



**CRAIG &
DERRICOTT**

INDUSTRIAL CATALOGUE



C&D CRAIG & DERRICOTT

www.craigandderricott.com

Automatic Transfer Switch
AC-33B Class PC Ulmp:8kV
Ue:AC400V 50Hz Ie:80A
Icw:10kA/0.03S Icm:17kA Iq:120kA IEC 60947-6-1

20
24

INTRODUCTION

Over the past 100 years, British manufacturing company Craig & Derricott have earned a strong reputation for customer service excellence and delivery of high-quality products.

Established in 1922, Craig & Derricott specialise in the design, manufacture and overhaul of low voltage switchgear and control-gear, rail rolling stock components and LED lighting, supplying to customers large and small around the world.

In 2017, Craig & Derricott became part of the Addtech Group, a Swedish technology group that develops and sells high-tech components, products and systems to industrial companies and the service industries around the world.



THE C&D VISION

We drive the success and profit of our customers through innovative and quality engineering, products and services. We strive to form strong and sustainable commercial partnerships, with a positive impact for sustainability, for key industries and for the planet. The world keeps changing, but after 100 years our passion stays the same.



OUR PRODUCTS

Initially, rotary switches formed the bulk of the company's production which was soon augmented by a range of heavy-duty pushbutton components and a wide selection of various limit switch formats.

Craig & Derricott offer a large range of products now including assembled electrical isolation switchgear, ATS, control stations, EV Chargers, rail rolling stock components and LED lighting.

Supported by a bespoke and special product service known as mi-switch, we offer our customers the opportunity to specify exact requirements which can be made to order.

OUR CUSTOMERS

Our customers extend around the world and operate in a wide variety of markets and sectors including Railway, Construction, Ventilation (Fire Rated), Explosion Proof, Medical, Military, Panel Builders and Power & Distribution.

Passionate for delivering a strong performance to all our shareholders, C&D are profitable, with consistent sales growth each year. The company is endlessly evolving its manufacturing equipment and techniques, while continuously improving and expanding on existing products in our collection of electrical control & switchgear and rail rolling stock components.

TECHNICAL GUIDANCE FOR PRODUCT SELECTION

INGRESS PROTECTION

When choosing a control device, apart from the electrical performance, consideration must be given to the environmental conditions in which the device will be placed. The item may be subjected to dust or dirt or it may come in contact with varying degrees of moisture. Indoor conditions will vary considerably but items may well be placed outdoors where the full influence of rain, ice & snow will be present. Protecting items to varying degrees is detailed in BS EN 60529:1992.

Employing a two digit code the standard defines protection against solid objects and separately protection against water i.e.

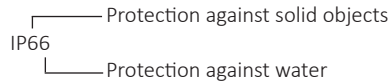

The following extract defines the IP categories used within this document.

1st Digit	Protection against solid objects	
0	Not Protected	
2		Protected against solid objects greater than Ø12.5
4		Protected against solid objects greater than Ø1.0
5		Protected against dust allowing a degree of ingress that isn't harmful to the assembly.
6		No ingress of dust.

2nd Digit	Protection against water	
0	Not Protected	
1		Protected against dripping water.
4		Protected against splashed water from any direction.
5		Protected against water jets from any direction.
6		Protected against strong water jets from any direction.

Please refer to BS EN 60529:1992 for full details.

PRODUCT GUIDE

Comparing to European standards (BS EN 60947-3) :-

DISCONNECTOR	A 'Disconnecter' is a mechanical switch which in the 'Open' position, complies with requirements specified for the isolating function. A 'Disconnecter' or 'Isolator' is an off-load device and marked 'Isolate elsewhere before opening' they have an AC20/DC20 utilisation category.
SWITCH	A 'Switch' is a mechanical switching device capable of making, carrying and breaking current under normal circuit conditions, which may include specified operating overload conditions. They also carry, for a specified time, currents under specified abnormal circuit conditions, such as those of short circuit (I.e. Utilisation category AC23A duty).
SWITCH-DISCONNECTOR	A 'Switch-disconnector' meets both of these criteria and with a Red/Yellow padlockable handle may also be called a 'Safety Isolator'.
CHANGEOVER SWITCH	A 'Changeover' device is used to connect to one of two sources and in this isolation application will require a central 'Off' position. In all other respects it conforms to the 'Switch-disconnector' requirements.
FUSE COMBINATION UNIT	A 'Switch-Disconnecter Fuse' is a combination of a mechanical switching device with fuses in a composite assembly.

CORROSIVE ENVIRONMENT

When choosing an enclosure, care must be taken to select the most suitable material taking into account the location, level of pollution, temperature, UV levels, vibration and humidity.

Typical enclosure materials include Aluminium, powder coated Mild Steel or Stainless Steel. Enclosures that are sealed to IP65 are commonly mistaken as being suitable for all outside environments. A powder coated mild steel or Aluminium enclosure will degrade and corrode under certain environmental conditions.

Installing enclosures in an external environment may also result in condensation forming on the inside of the enclosure, resembling water ingress. This is caused by a difference in temperature between inner and outer surfaces of the enclosure and the most common solution is to fit an anti-condensation heater and breather gland within the enclosure.

When the product is subject to chemical cleaning a Stainless Steel enclosure is recommended although the correct grade of Stainless Steel must be selected. If in doubt, please consult our technical department on sales@craigandderricott.com or +44(0)1543 375 541.

CONTENTS



ENCLOSED SWITCHGEAR			PANEL SWITCHES	
SDDG Die-Cast Aluminium		1	Compact Range	51
EDDG Die-Cast Aluminium		2	Standard Range	51
SDP Moulded Plastic		3	Changeover Range	51
EDMP Moulded Plastic	NEW	4	Fuse Combination Range	52
Photovoltaic (PV)		5	Photovoltaic (PV) Range	52
Sheet Steel		6	Accessories	53
Stainless Steel		7	Technical Specification	54
Sloping Roof		8	Dimensions	57
Flush Mounting		9	CONTROL STATIONS	
Hinged Door		10	Emergency Stop	61
GRP		11	EPO	64
Accessories		12	Stop, Start & Stop/Start	65
Technical Specification		14	Explosion Proof	67
Dimensions		18	16 Series Components	68
FIRE RATED SWITCHGEAR			22 Series Components	69
F200 Fire Rated		24	32 Series Components	70
F400 Fire Rated		26	Contact Blocks	72
Junction Boxes		29	Technical Specification	74
TFL / LU SWITCHGEAR			SAFETY ENCLOSED SWITCHES	
Die-Cast Aluminium		31	GW Grabwires	76
Stainless Steel		31	LW Grabwires	79
Hinged Door		32	EV CHARGERS	
Fire Rated		33	Smart ION Chargers	82
Automatic Transfer Switches		34	STANDARD ROTARY SWITCHES	84
Technical Specification		35	CLASSIC ROTARY SWITCHES	85
Dimensions		35	FLAGGED ISOLATORS	86
EXPLOSION PROOF SWITCHGEAR			BESPOKE DESIGN	87
Zone 1 & 2 EX DB EB TB		39		
Zone 22		40		
Technical Specification		41		
Dimensions		42		
AUTOMATIC TRANSFER SWITCHES (ATS)				
Mercia Panel Switches	NEW	44		
Mercia Standard ATS	NEW	44		
Mercia Form 3 Type ATS	NEW	45		
Mercia Single Line Bypass ATS	NEW	45		
Mercia Dual Line Bypass ATS	NEW	46		
Mimic Panels		46		
Motorised Form 4 Type 2 with Bypass ATS		47		
Solenoid Form 4 Type 2 with Single Line ATS		48		
Solenoid Form 4 Type 2 with Dual Line ATS		49		

ENCLOSED SWITCHGEAR

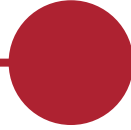

Craig & Derricott has been at the forefront of switchgear design and manufacture for 100 years, and in that time the requirements of the installer & end user have always been paramount in the design concept. This attitude has culminated in the design of the 'i-switch' range where a wider choice of products has been offered to the customer, all of which are simple to install and provide the user with a product that is safe and effective in use.

The 'i-switch' range provides the user with a wide choice of products to safely disconnect an item of electrical equipment from the supply and are primarily designed to comply with the following minimum requirements:-

- Provide an effective clearance between the supply and the load appropriate to the voltage applied.
- Provide a means of locking in the 'Off' position. (Padlocking)
- Provide a true indication of the contact state.
- Provide a safe disconnection from the supply even under fault conditions.

All of Craig & Derricott's products meet, and often exceed, the above requirements making each one a product of choice in today's market.



SDDG DIE-CAST ALUMINIUM ENCLOSED SWITCHGEAR

A range of Die-Cast Aluminium enclosed isolation equipment with sealing up to IP66 available in Light Grey (RAL 7035) or Traffic Red (RAL3020) powder coated finish. These units can be placed in environments where resistance to impacts, moisture and dust/dirt are a concern. All units have a padlockable handle which allows for the insertion of up to three padlocks in the 'Off' position thus preventing the isolator being switched to the 'On' position. All units are interlocked in the ON position preventing the lid from being removed and when padlocked in the OFF position. The option to add a selection of auxiliary blocks providing additional contacts and a choice of Neutral assemblies increases the flexibility of the product range. Compliant to IEC / BS EN 60947-3.

Enclosures finished Red (RAL 3020) are available to order, please contact our Sales team for details. Replace 'G' in the Cat. No. to 'R' e.g. SDDR253N

'N' = switched neutral (early make, late break) | 'NL' = unswitched neutral | 'EB' = 2 N/O early break auxiliary contacts

Add suffix '/10' to the Cat. No. for padlocking in the 'On' position e.g. SDDG253/10

Switch Disconnectors (O-I)									
Image	Rating	Format	Interior Switch	Cat No.	Encl. Size	Encl. Material	Encl. Colour	IP Rating	Cable Entries
	20A	6P	GX20	SDDG206	A	Die-Cast Aluminium	Light Grey RAL 7035	IP66	2xM20 On Bottom Face
		6P+2EB Aux		SDDG206EB					
	25A	2P	CS25	SDDG252	A	Die-Cast Aluminium	Light Grey RAL 7035	IP66	2xM20 On Bottom Face
		3P		SDDG253					
		3P+N		SDDG253N					
		3P+NL		SDDG253NL					
		3P+2EB Aux		SDDG253EB					
	32A	2P	CS32	SDDG322	A	Die-Cast Aluminium	Light Grey RAL 7035	IP66	2xM20 On Bottom Face
		3P		SDDG323					
		3P+N		SDDG323N					
		3P+NL		SDDG323NL					
		3P+2EB Aux		SDDG323EB					
	40A	2P	CS40R	SDDG402X	A	Die-Cast Aluminium	Light Grey RAL 7035	IP66	2xM25 On Bottom Face
		3P		SDDG403X					
		3P+N		SDDG403NX					
3P+NL		SDDG403NLX							
3P+2EB Aux		SDDG403EBX							
40A		2P	GX40	SDDG402	B	Die-Cast Aluminium	Light Grey RAL 7035	IP65	2xM25 + 1xM20 On Bottom Face
		3P		SDDG403					
		3P+N		SDDG403N					
		3P+NL		SDDG403NL					
		3P+2EB Aux		SDDG403EB					
63A	2P	CS63	SDDG632	B	Die-Cast Aluminium	Light Grey RAL 7035	IP65	2xM25 + 1xM20 On Bottom Face	
	3P		SDDG633						
	3P+N		SDDG633N						
	3P+NL		SDDG633NL						
	3P+2EB Aux		SDDG633EB						
	6P		SDDG636						
	6P+2EB Aux		SDDG636EB						
80A	3P	CS80	SDDG803	B	Die-Cast Aluminium	Light Grey RAL 7035	IP65	2xM32 + 1xM20 On Bottom Face	
	3P+N		SDDG803N						
	3P+NL		SDDG803NL						
Changeover Switch Disconnectors (I-O-II)									
	20A	2P	GX20	SCODDG202	A	Die-Cast Aluminium	Light Grey RAL 7035	IP66	2xM20 On Bottom Face
		3P		SCODDG203					
		4P		SCODDG204					
	40A	2P	GX40	SCODDG402	B	Die-Cast Aluminium	Light Grey RAL 7035	IP65	2xM25 + 1xM20 On Bottom Face
		3P		SCODDG403					
		4P		SCODDG404					

EDDG DIE-CAST ALUMINIUM ENCLOSED SWITCHGEAR

A range of Die-Cast Aluminium enclosed isolation equipment with sealing up to IP66. All units have a padlockable handle which allows for an insertion of up to three padlocks in the 'Off' position thus preventing the isolator being switched to the 'On' position. All units are interlocked in the ON position preventing the lid from being removed and when padlocked in the OFF position. The option to add a selection of auxiliary blocks providing additional contacts and a choice of Neutral assemblies increases the flexibility of the product range. Compliant to IEC / BS EN 60947-3.

'N' = switched neutral (early make, late break) | 'NL' = unswitched neutral | 'EB' = 2 N/O early break auxiliary contacts | 'CO' = 1N/O + 1N/C auxiliary early break contacts

Add suffix '/10' to the Cat. No. for padlocking in the 'On' position e.g. EDDG633/10

Switch Disconnectors (O-I)									
Image	Rating	Format	Interior Switch	Cat No.	Encl. Size	Encl. Material	Encl. Colour	IP Rating	Cable Entries
	20A	6P	GX20	EDDG206	C	Die-Cast Aluminium	Light Grey RAL 7035	IP66	2 x M20 Btm only
		6P+2EB Aux		EDDG206EB					
	25A	2P	K25	EDDKG252	C	Die-Cast Aluminium	Light Grey RAL 7035	IP66	2 x M20 Btm only
		3P		EDDKG253					
		3P+N		EDDKG253N					
		3P+NL		EDDKG253NL					
		3P+1NO/1NC		EDDKG253CO					
	32A	2P	K32	EDDKG322	C	Die-Cast Aluminium	Light Grey RAL 7035	IP66	2 x M20 Btm only
		3P		EDDKG323					
		3P+N		EDDKG323N					
3P+NL		EDDKG323NL							
3P+1NO/1NC		EDDKG323CO							
40A	2P	K40	EDDKG402	C	Die-Cast Aluminium	Light Grey RAL 7035	IP66	2 x M20 Btm only	
	3P		EDDKG403						
	3P+N		EDDKG403N						
	3P+NL		EDDKG403NL						
	3P+1NO/1NC		EDDKG403CO						
	6P	GX40	EDDG406	B			IP65	2 x M25 & 1 x M20 Btm Only	
6P+2EB Aux	EDDG406EB								
	63A	2P	CS63	EDDG632	B	Die-Cast Aluminium	Light Grey RAL 7035	IP65	2 x M25 & 1 x M20 Btm Only
		3P		EDDG633					
		3P+N		EDDG633N					
		3P+NL		EDDG633NL					
		3P+2EB Aux		EDDG633EB					
		6P		EDDG636					
		6P+2EB Aux		EDDG636EB					
80A	2P	CS80	EDDG802	B	Die-Cast Aluminium	Light Grey RAL 7035	IP65	2 x M25 & 1 x M20 Btm Only	
	3P		EDDG803						
	3P+N		EDDG803N						
	3P+NL		EDDG803NL						
	3P	GA080A	EDDG803T						
	3P+N		EDDG803NT						
	3P+NL		EDDG803NLT						

SDP MOULDED PLASTIC ENCLOSED SWITCHGEAR

A range of moulded plastic enclosed isolation equipment with sealing up to IP66. All units have a padlockable handle which allow for the insertion of up to three padlocks in the 'Off' position thus preventing the isolator being switched to the 'On' position. All units are interlocked in the ON position preventing the lid from being removed and when padlocked in the OFF position. The option to add a selection of auxiliary blocks providing additional contacts and a choice of Neutral assemblies increases the flexibility of the product range. Compliant to IEC / BS EN 60947-3.

'N' = switched neutral (early make, late break) | 'NL' = unswitched neutral | 'EB' = 2 N/O early break auxiliary contacts

Add suffix '/10' to the Cat. No. for padlocking in the 'On' position e.g. SDP253/10

Switch Disconnectors (O-I)										
Image	Rating	Format	Interior Switch	Cat No.	Encl. Size	Encl. Material	Encl. Colour	IP Rating	Cable Entries	
	20A	6P	GX20	SDP206	A	PC / ABS	Light Grey RAL 7035	IP66	2 x M20 Knock-outs Top & Btm	
		6P+2EB Aux		SDP206EB						
	25A	2P	CS25	SDP252	A	PC / ABS	Light Grey RAL 7035	IP66	2 x M20 Knock-outs Top & Btm	
		3P		SDP253						
		3P+N		SDP253N						
		3P+NL		SDP253NL						
		3P+2EB Aux		SDP253EB						
	32A	2P	CS32	SDP322	A	PC / ABS	Light Grey RAL 7035	IP66	2 x M20 Knock-outs Top & Btm	
		3P		SDP323						
		3P+N		SDP323N						
		3P+NL		SDP323NL						
		3P+2EB Aux		SDP323EB						
		40A	2P	CS40R	SDP402	B	PC / ABS	Light Grey RAL 7035	IP65	2 x M20/25 Knock-outs Top & Btm. Back Face - 2 x M20 Knock-outs
3P			SDP403							
3P+N			SDP403N							
3P+NL			SDP403NL							
3P+2EB Aux			SDP403EB							
6P			GX40		SDP406					
6P+2EB Aux		SDP406EB								
63A		2P	CS63	SDP632	B	PC / ABS	Light Grey RAL 7035	IP65	2 x M20/25 Knock-outs Top & Btm. Back Face - 2 x M20 Knock-outs	
		3P		SDP633						
		3P+N		SDP633N						
		3P+NL		SDP633NL						
		3P+2EB Aux		SDP633EB						
		80A	2P	CS80	SDP802	C	PC	Light Grey RAL 7035	IP65	Blank Sides
	3P		SDP803							
	3P+N		SDP803N							
	3P+NL		SDP803NL							
	3P+2EB Aux		SDP803EB							
	100A	2P	CS100	SDP1002	D	PC	Light Grey RAL 7035	IP65	Blank Sides	
		3P		SDP1003						
		3P+N		SDP1003N						
		3P+NL		SDP1003NL						
		3P+2EB Aux		SDP1003EB						
	Changeover Switch Disconnectors (I-O-II)									
		20A	2P	GX20	SCODP202	A	PC / ABS	Light Grey RAL 7035	IP66	2 x M20 Knock-outs Top & Btm
			3P		SCODP203					
4P			SCODP204							
	40A	2P	GX40	SCODP402	B	PC / ABS	Light Grey RAL 7035	IP65	2 x M20/25 Knock-outs Top & Btm. Back Face - 2 x M20 Knock-outs	
		3P		SCODP403						
		4P		SCODP404						



EDMP MOULDED PLASTIC ENCLOSED SWITCHGEAR

A NEW range of moulded plastic enclosed isolation equipment with sealing up to IP66.

This range of 4P isolators are rated 25A to 63A, providing a 3-in-1 switch for the end user. Each unit can be utilised for 2P, 3P and 4P requirements. The spacious IP66 moulded plastic enclosure, comes with four external fixing holes and an the option to remove the internal switch from the built in din rail for easy cabling and a quick installation.

All four variants have a red safety padlockable handle, which allows for an insertion of up to three padlocks in the 'Off' position thus preventing the isolator being switched to the 'On' position. All units are interlocked in the ON position preventing the lid from being removed and when padlocked in the OFF position.

Each unit has been independently tested and is competitively priced for the industrial market. Contact your local area sales manager today for more information. Compliant to IEC / BS EN 60947-3.

Switch Disconnectors (O-I)									
Image	Rating	Format	Interior Switch	Cat No.	Encl. Size	Encl. Material	Encl. Colour	IP Rating	Cable Entries
	25A	4P	K25	EDMP254	EA	PC / ABS	Light Grey RAL 7047	IP66	2xM12/M20 knock-outs top and btm
	32A	4P	K32	EDMP324	EA	PC / ABS	Light Grey RAL 7047	IP66	2xM12/M20 knock-outs top and btm
	40A	4P	K40	EDMP404	EA	PC / ABS	Light Grey RAL 7047	IP66	2xM12/M20 knock-outs top and btm
	63A	4P	K63	EDMP634	EB	PC / ABS	Light Grey RAL 7047	IP66	2xM20/M25 knock-outs top and btm

PHOTOVOLTAIC (PV) ENCLOSED SWITCHGEAR

Solar power is an environmentally friendly method of producing electricity and is achieved using Photovoltaic (PV) cells that capture sunlight and convert it to electricity. By combining cells into an array, different voltages and current combinations can be achieved. Once installed an array will continue to generate voltage and current and it is therefore essential to isolate the array in the event of a fault or for maintenance purposes. To enable this Craig & Derricott have developed a range of DC Switch Disconnectors to manage this specific application.

Our range of true A.C and D.C photovoltaic isolators, developed to meet the unique requirements of Solar Panel technology and based upon our well-established i-switch family of products. Rated up to IP66 these PV isolators are enclosed in a moulded plastic enclosure. All units have a padlockable handle which allows for an insertion of up to three padlocks in the 'Off' position thus preventing the isolator being switched to the 'On' position. The option to add a selection of auxiliary blocks providing additional contacts and a choice of Neutral assemblies increases the flexibility of the product range.

Pre-cabled DC isolators and PV Bundle packs of one AC and one DC isolators are available as an alternative options to provide users with the complete PV isolation solution.

Switch Disconnectors (O-I)											
Image	Rating	Format	Max. DC Voltage	Cat No.	Encl. Size	Encl. Material	Encl. Colour	IP Rating	Cable Entries		
	16A	DC 2P	1,000V	EPV162	E	PA / ABS	Light Grey RAL 7035	IP66	2 x M20 Knock-outs Top & Btm & Back		
		DC 4P	1,500V	PVP164	B			IP65	1 x M20 & M25 Knock-outs Top & Btm. 2 x M20 Knock-outs Back		
		Twin Array DC 2x 2P	1,000V	PVP1622							
	25A	DC 2P	1,000V	EPV252	E	PA / ABS	Light Grey RAL 7035	IP66	2 x M20 Knock-outs Top & Btm & Back		
		DC 3P	1,000V	EPV253				B	IP65	1 x M20 & M25 Knock-outs Top & Btm. 2 x M20 Knock-outs Back	
		DC 4P	1,000V	PVP254							
	32A	Twin Array DC 2x 2P	DC 2P	600V	EPV322	E	PA / ABS	Light Grey RAL 7035	IP66	2 x M20 Knock-outs Top & Btm & Back	
			DC 3P	1,000V	EPV323				B	IP65	1 x M20 & M25 Knock-outs Top & Btm. 2 x M20 Knock-outs Back
			DC 4P	1,500V	PVP324						
			DC 2P	600V	PVP3222						
	40A	Twin Array DC 2x 2P	DC 2P	300V/400V	EPV402	E	PA / ABS	Light Grey RAL 7035	IP66	2 x M20 Knock-outs Top & Btm & Back	
			DC 3P	800V	EPV403				B	IP65	1 x M20 & M25 Knock-outs Top & Btm. 2 x M20 Knock-outs Back
			DC 4P	1,500V	PVP404						
			DC 2P	300V/400V	PVP4022						
	Pre-wired Switch Disconnectors (O-I)										
		16A	DC 2P	1,000V	EPV162C	E	PA / ABS	Light Grey RAL 7035	IP66	Flying Leads with MC4 Connectors Top & Btm	
PVP162C					A						
	16A	DC 2P	1,000V	EPV162P	E	PA/ABS	Light Grey RAL 7035	IP66	Panel Mounted MC4 Connectors		
				PVP162P	A						

Switch Diagrams

EPV**2 / PVP**2



EPV**3 / PVP**3

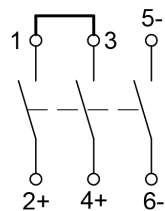

EPV**4 / PVP**4

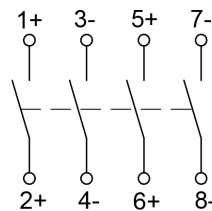

PVP**22

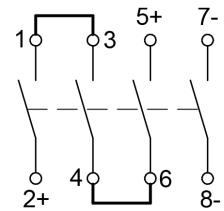

SHEET STEEL ENCLOSED SWITCHGEAR

A range of Sheet Steel enclosed isolation equipment sealed to IP66, providing the user with a robust and cost effective assembly. Each unit is supplied with a polyester powder coated finish in Light Grey (RAL 7035).

The range is supplied with a handle manufactured from a material suitable to withstand cleaning products containing sodium hydroxide. The handle is padlockable allowing for the insertion of up to three padlocks in the 'Off' position, thus preventing the isolator being switched to the 'On' position. All units are interlocked in the ON position preventing the lid from being removed. Standard shackle diameter $\varnothing 6.4$ earth continuity terminals are provided in the base and lid of each enclosure.

The option to add a selection of auxiliary blocks providing additional contacts and a choice of Neutral assemblies increases the flexibility of the product range. External mounting feet in Stainless Steel are offered as an accessory sized to match each enclosure.

'N' = switched neutral (early make, late break) | 'NL' = unswitched neutral | 'EB' = 2 N/O early break auxiliary contacts

Switch Disconnectors (O-I)															
Image	Rating	Format	Interior Switch	Cat No.	Encl. Size	Encl. Material	Encl. Colour	IP Rating	Cable Entries						
	20A	6P	GX20	SDMG206	A	Sheet Steel	Light Grey RAL 7035	IP66	2 x M20						
		6P+2EB Aux		SDMG206EB											
	25A	2P	CS25	SDMG252	A	Sheet Steel	Light Grey RAL 7035	IP66	2 x M20						
		3P		SDMG253											
		3P+N		SDMG253N											
		3P+NL		SDMG253NL											
		3P+2EB Aux		SDMG253EB											
	32A	2P	CS32	SDMG322	A	Sheet Steel	Light Grey RAL 7035	IP66	2 x M20						
		3P		SDMG323											
		3P+N		SDMG323N											
		3P+NL		SDMG323NL											
		3P+2EB Aux		SDMG323EB											
		40A	2P	CS40R	SDMG402	B	Sheet Steel	Light Grey RAL 7035	IP66	2 x M20 + 2 x M25					
3P			SDMG403												
3P+N			SDMG403N												
3P+NL			SDMG403NL												
3P+2EB Aux			SDMG403EB												
63A		6P	GX40	SDMG406	B	Sheet Steel	Light Grey RAL 7035	IP66	2 x M20 + 2 x M25						
		6P+2EB Aux		SDMG406EB											
		2P		CS63						SDMG632	B	Sheet Steel	Light Grey RAL 7035	IP66	2 x M20 + 2 x M25
		3P								SDMG633					
		3P+N								SDMG633N					
3P+NL	SDMG633NL														
3P+2EB Aux	SDMG633EB														
	80A	2P	GA080A	SDMG802	C	Sheet Steel	Light Grey RAL 7035	IP66	-						
		3P		SDMG803											
		3P+1EB		SDMG803/1EB											
		3P+N		SDMG803N											
		3P+NL		SDMG803NL											
	100A	2P	GA0100A	SDMG1002	C	Sheet Steel	Light Grey RAL 7035	IP66	-						
		3P		SDMG1003											
		3P+1EB		SDMG1003/1EB											
		3P+N		SDMG1003N											
		3P+NL		SDMG1003NL											
Changeover Switch Disconnectors (I-O-II)															
	20A	2P	GX20	SCODMG202	A	Sheet Steel	Light Grey RAL 7035	IP66	2 x M20						
		3P		SCODMG203											
		4P		SCODMG204											
	40A	2P	GX40	SCODMG402	B	Sheet Steel	Light Grey RAL 7035	IP66	2 x M20 + 2 x M25						
		3P		SCODMG403											
		4P		SCODMG404											

STAINLESS STEEL ENCLOSED SWITCHGEAR

A range of isolation equipment housed in Grade 304 Stainless Steel enclosures sealed to IP66. The range is supplied with a handle manufactured from a material suitable to withstand cleaning products containing sodium hydroxide. The handle is padlockable allowing for the insertion of up to three padlocks in the 'Off' position, thus preventing the isolator being switched to the 'On' position. All units are interlocked in the ON position preventing the lid from being removed.

The option to add a selection of auxiliary blocks providing additional contacts and a choice of Neutral assemblies increases the flexibility of the product range. External mounting feet in Stainless Steel are offered as an accessory sized to match each enclosure.

Stainless Steel Grade 316 enclosures are available on request.

'N' = switched neutral (early make, late break) | 'NL' = unswitched neutral | 'EB' = 2 N/O early break auxiliary contacts

Switch Disconnectors (O-I)									
Image	Rating	Format	Interior Switch	Cat No.	Encl. Size	Encl. Material	Encl. Colour	IP Rating	Cable Entries
	20A	6P	GX20	SDS206	A	Stainless Steel Grade 304	Brushed Satin Finish	IP66	2 x M20
		6P+2EB Aux		SDS206EB					
	25A	2P	CS25	SDS252	A	Stainless Steel Grade 304	Brushed Satin Finish	IP66	2 x M20
		3P		SDS253					
		3P+N		SDS253N					
		3P+NL		SDS253NL					
		3P+2EB Aux		SDS253EB					
	32A	2P	CS32	SDS322	A	Stainless Steel Grade 304	Brushed Satin Finish	IP66	2 x M20
		3P		SDS323					
		3P+N		SDS323N					
		3P+NL		SDS323NL					
		3P+2EB Aux		SDS323EB					
		40A	2P	CS40R	SDS402	B	Stainless Steel Grade 304	Brushed Satin Finish	IP66
3P			SDS403						
3P+N			SDS403N						
3P+NL			SDS403NL						
3P+2EB Aux			SDS403EB						
6P		GX40	SDS406	B	Stainless Steel Grade 304	Brushed Satin Finish	IP66	2 x M20 + 2 x M25	
			6P+2EB Aux						SDS406EB
63A		2P	CS63	SDS632	B	Stainless Steel Grade 304	Brushed Satin Finish	IP66	2 x M20 + 2 x M25
		3P		SDS633					
		3P+N		SDS633N					
	3P+NL	SDS633NL							
	3P+2EB Aux	SDS633EB							
Changeover Switch Disconnectors (I-O-II)									
	20A	2P	GX20	SCODS202	A	Stainless Steel Grade 304	Brushed Satin Finish	IP66	2 x M20
		3P		SCODS203					
		4P		SCODS204					
	40A	2P	GX40	SCODS402	B	Stainless Steel Grade 304	Brushed Satin Finish	IP66	2 x M20 + 2 x M25
		3P		SCODS403					
		4P		SCODS404					

SLOPING ROOF ENCLOSED SWITCHGEAR

A range of isolation equipment housed in Grade 316 Stainless Steel enclosures, supplied with a specially designed Stainless Steel 'sloping roof'. These units are ideally suited for hygienic environments with their associated severe cleaning routines. The design has been created to minimise areas where dirt can accumulate and incorporates a flush rear surface and universal fixing sealed to IP66.

The range is supplied with a handle manufactured from a material suitable to withstand cleaning products containing sodium hydroxide. The handle is padlockable allowing for the insertion of up to three padlocks in the 'Off' position, thus preventing the isolator being switched to the 'On' position. All units are interlocked in the ON position preventing the lid from being removed. The option to add a selection of auxiliary blocks providing additional contacts and a choice of Neutral assemblies increases the flexibility of the product range. External mounting feet in Stainless Steel are offered as an accessory sized to match each enclosure.

'N' = switched neutral (early make, late break) | 'EB' = 2 N/O early break auxiliary contacts

Optional pre-drilled bottom entries can be supplied. For 2xM20 in Size A Enclosures add suffix '/M20' to the Cat. No. E.g. SDSSR253/M20 | For 2xM25 in Size B Enclosures add suffix '/M25' to the Cat. No. E.g. SDSSR253/M25.

Switch Disconnectors (O-I)										
Image	Rating	Format	Interior Switch	Cat No.	Encl. Size	Fascia plate Material	Encl. Material	IP Rating	Roof Angle	Cable Entries
	20A	6P	GX20	SDSSR206	A	Stainless Steel Grade 316	Brushed Satin Finish	IP66	15° Slope	None
		6P+2EB Aux		SDSSR206EB						
	25A	2P	CS25	SDSSR252	A	Stainless Steel Grade 316	Brushed Satin Finish	IP66	15° Slope	None
		3P		SDSSR253						
		3P+N		SDSSR253N						
		3P+2EB Aux		SDSSR253EB						
	32A	2P	CS32	SDSSR322	A	Stainless Steel Grade 316	Brushed Satin Finish	IP66	15° Slope	None
		3P		SDSSR323						
		3P+N		SDSSR323N						
		3P+2EB Aux		SDSSR323EB						
	40A	2P	CS40R	SDSSR402	B	Stainless Steel Grade 316	Brushed Satin Finish	IP66	15° Slope	None
		3P		SDSSR403						
		3P+N		SDSSR403N						
		3P+2EB Aux		SDSSR403EB						
		6P	GX40	SDSSR406						
	6P+2EB Aux	SDSSR406EB								
	63A	2P	CS63	SDSSR632	B	Stainless Steel Grade 316	Brushed Satin Finish	IP66	15° Slope	None
		3P		SDSSR633						
		3P+N		SDSSR633N						
		3P+2EB Aux		SDSSR633EB						
80A	2P	CS80	SDSSR802	B	Stainless Steel Grade 316	Brushed Satin Finish	IP66	15° Slope	None	
	3P		SDSSR803							
	3P+N		SDSSR803N							
	3P+2EB Aux		SDSSR803EB							

FLUSH MOUNTING SWITCHGEAR

A range of flush mounting isolation equipment ranging 20A to 63A, supplied with a Sheet Steel back box and Stainless Steel fascia plate sealed up to IP65. This range is designed for installation in kitchens, laboratories, food processing areas, hospitals and many other areas.

The range is supplied with a handle manufactured from a material suitable to withstand cleaning products containing sodium hydroxide. The handle is padlockable allowing for the insertion of up to three padlocks in the 'Off' position, thus preventing the isolator being switched to the 'On' position. All units are interlocked in the ON position preventing the lid from being removed.

To maintain the sealing overall, an efficient bond must be made using some form of gasket material. This is particularly vital on tiled surfaces where grout lines can channel moisture down the wall. A continuous bead of moisture resistant mastic is a simple way of providing a seal, and can improve the appearance of the final assembly on an uneven surface.

The option to add a selection of auxiliary blocks providing additional contacts and a choice of Neutral assemblies increases the flexibility of the product range. External mounting feet in Stainless Steel are offered as an accessory sized to match each enclosure.

Switch Disconnectors (O-I)									
Image	Rating	Format	Interior Switch	Cat No.	Encl. Size	Fascia plate Material	Back Box Material	IP Rating	Cable Entries
	20A	2P	GX20	SDFL202	A	Brushed Stainless Steel Grade 304	Zinc Plated Sheet Steel	Isolating switch to Stainless Steel fascia plate IP65	Knock-outs In Back Box
		3P		SDFL203					
		4P		SDFL204					
	32A	2P	GX32	SDFL322	B	Brushed Stainless Steel Grade 304	Zinc Plated Sheet Steel	Isolating switch to Stainless Steel fascia plate IP65	Knock-outs In Back Box
		3P		SDFL323					
		4P		SDFL324					
	40A	2P	GX40	SDFL402	B	Brushed Stainless Steel Grade 304	Zinc Plated Sheet Steel	Isolating switch to Stainless Steel fascia plate IP65	Knock-outs In Back Box
		3P		SDFL403					
		4P		SDFL404					
	63A	2P	GN63	SDFL632	C	Brushed Stainless Steel Grade 304	Zinc Plated Sheet Steel	Isolating switch to Stainless Steel fascia plate IP65	Knock-outs In Back Box
		3P		SDFL633					
		4P		SDFL634					
	80A	2P	CS80	SDFLL0802	D	Brushed Stainless Steel Grade 304	Zinc Plated Sheet Steel	Isolating switch to Stainless Steel fascia plate IP65	None
		3P		SDFLL0803					
		4P		SDFLL0804					
	100A	2P	CS100	SDFLL1002	E	Brushed Stainless Steel Grade 304	Zinc Plated Sheet Steel	Isolating switch to Stainless Steel fascia plate IP65	None
		3P		SDFLL1003					
		4P		SDFLL1004					

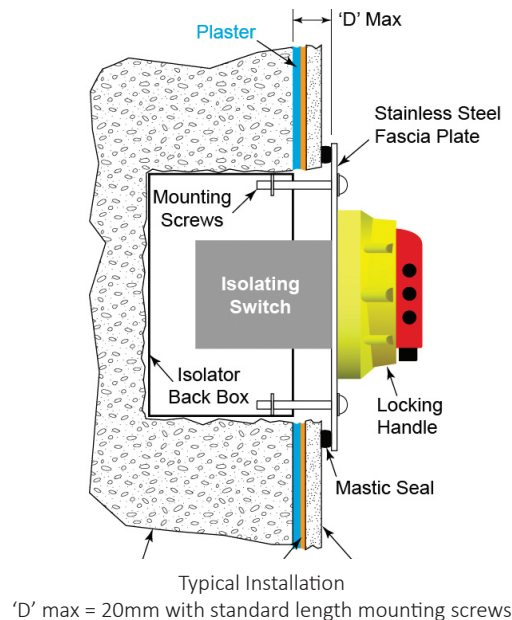

SHEET STEEL HINGED DOOR SWITCHGEAR

A range of 'hinged door' Light Grey (RAL 7035) powder coated Sheet Steel isolation equipment. Supplied in IP65 generously sized boxes to help avoid the need for extension boxes. All enclosures have the switches mounted on a removable galvanised chassis plate. All units are provided with removable top & bottom gland plates.

The range has a padlockable handle which allows for the insertion of up to three padlocks in the "Off" position. The hinged door cannot be opened in the ON position or when the hand is padlocked in the OFF position. For padlocking in both 'Off' and 'On' positions, add '/10' to the catalogue no. E.g. EDG00323N/10. The door interlock handle can be defeated to enable emergency opening or for testing purposes (100A and above). The option to add a selection of auxiliary blocks providing additional contacts and a choice of Neutral assemblies increases the flexibility of the product range.

Flagged hinged door isolators are available upon request.

Red (RAL 3020) painted Sheet Steel and Stainless Steel (Grade 304 & 316) enclosures are available on request for the more severe environments. Contact our sales team on 01543 375 541 for further information. Compliant to IEC / BS EN 60947-3.

'N' = switched neutral | 'NL' = unswitched neutral (100% rated 32A-200A, 50% rated 250A-1250A) | 'EB' = 2 N/O early break auxiliary contacts

Switch Disconnectors (O-I)								
Image	Rating	Format	Cat No.	Encl. Size	Encl. Material	Encl. Colour	IP Rating	Cable Entries
	32A	3P+N	EDG00323N	1	Sheet Steel	Light Grey RAL 7035	IP65	Gland Plates
		3P+NL	EDG00323NL					
	63A	3P+N	EDG00633N	1	Sheet Steel	Light Grey RAL 7035	IP65	Gland Plates
		3P+NL	EDG00633NL					
		6P	EDG00636					
		6P+2EB Aux	EDG00636EB					
80A	3P+N	EDG00803N	1	Sheet Steel	Light Grey RAL 7035	IP65	Gland Plates	
	3P+NL	EDG00803NL						
	6P	EDG00806						
	100A	3P+N	EDG01003N	1	Sheet Steel	Light Grey RAL 7035	IP65	Gland Plates
		3P+NL	EDG01003NL	5				
		6P	EDG01006	5				
	125A	3P+N	EDG01253N	3	Sheet Steel	Light Grey RAL 7035	IP65	Gland Plates
		3P+NL	EDG01253NL					
		6P	EDG01256					
	160A	3P+N	EDG01603N	3	Sheet Steel	Light Grey RAL 7035	IP65	Gland Plates
		3P+NL	EDG01603NL					
		6P	EDG01606					
	200A	3P+N	EDG02003N	7	Sheet Steel	Light Grey RAL 7035	IP65	Gland Plates
		3P+NL	EDG02003NL	10				
		6P	EDG02006	10				
	250A	3P+N	EDG02503N	9	Sheet Steel	Light Grey RAL 7035	IP65	Gland Plates
		3P+NL	EDG02503NL					
		6P+2EB Aux	EDG02506EB					
400A	3P+N	EDG04003N	11	Sheet Steel	Light Grey RAL 7035	IP65	Gland Plates	
	3P+NL	EDG04003NL						
	630A	3P+N	EDG06303N	13	Sheet Steel	Light Grey RAL 7035	IP65	Gland Plates
		3P+NL	EDG06303NL					
	800A	3P+N	EDG08003N	13	Sheet Steel	Light Grey RAL 7035	IP65	Gland Plates
		3P+NL	EDG08003NL					
	1000A	3P+N	EDG10003N	14	Sheet Steel	Light Grey RAL 7035	IP65	Gland Plates
		3P+NL	EDG10003NL					
	1250A	3P+N	EDG12503N	14	Sheet Steel	Light Grey RAL 7035	IP65	Gland Plates
		3P+NL	EDG12503NL					
Changeover Switch Disconnectors (I-O-II)								
	63A	4P	ECODG00634	4	Sheet Steel	Light Grey RAL 7035	IP65	Gland Plates
	100A	4P	ECODG01004	4	Sheet Steel	Light Grey RAL 7035	IP65	Gland Plates
	125A	4P	ECODG01254	8	Sheet Steel	Light Grey RAL 7035	IP65	Gland Plates
	160A	4P	ECODG01604	8	Sheet Steel	Light Grey RAL 7035	IP65	Gland Plates
	200A	4P	ECODG02004	8	Sheet Steel	Light Grey RAL 7035	IP65	Gland Plates
	250A	4P	ECODG02504	10	Sheet Steel	Light Grey RAL 7035	IP65	Gland Plates
	400A	4P	ECODG04004	13	Sheet Steel	Light Grey RAL 7035	IP65	Gland Plates
	630A	4P	ECODG06304	13	Sheet Steel	Light Grey RAL 7035	IP65	Gland Plates

Fuse Combination Units (O-I)								
Image	Rating	Format	Cat No.	Encl. Size	Encl. Material	Encl. Colour	IP Rating	Cable Entries
	32A	3P+NL	EDFG00323NL	2	Sheet Steel	Light Grey RAL 7035	IP65	Gland Plates
	63A	3P+NL	EDFG00633NL	2	Sheet Steel	Light Grey RAL 7035	IP65	Gland Plates
	100A	3P+NL	EDFG01003NL	6	Sheet Steel	Light Grey RAL 7035	IP65	Gland Plates
	125A	3P+NL	EDFG01253NL	6	Sheet Steel	Light Grey RAL 7035	IP65	Gland Plates
	160A	3P+NL	EDFG01603NL	6	Sheet Steel	Light Grey RAL 7035	IP65	Gland Plates
	200A	3P+NL	EDFG02003NL	8	Sheet Steel	Light Grey RAL 7035	IP65	Gland Plates
	250A	3P+NL	EDFG02503NL	8	Sheet Steel	Light Grey RAL 7035	IP65	Gland Plates
	315A	3P+NL	EDFG03153NL	12	Sheet Steel	Light Grey RAL 7035	IP65	Gland Plates
	400A	3P+NL	EDFG04003NL	12	Sheet Steel	Light Grey RAL 7035	IP65	Gland Plates
	630A	3P+NL	EDFG06303NL	13	Sheet Steel	Light Grey RAL 7035	IP65	Gland Plates
	800A	3P+NL	EDFG08003NL	13	Sheet Steel	Light Grey RAL 7035	IP65	Gland Plates

GRP HINGED DOOR SWITCHGEAR

Our range of 'hinged door' Light Grey (RAL 7035) Glass Fibre Reinforced Polyester (GRP) switch disconnectors are supplied in IP65 enclosures, generously sized to avoid the need for cable extension boxes. All switches are mounted on removable galvanised chassis plates.

The isolators have a padlockable handle which allows for the insertion of up to three padlocks in the 'Off' position thus preventing the isolator being switched to the 'On' position. The door interlock handle can be defeated to enable emergency opening or for testing purposes (100A and above).

Suitable for use in harsh and demanding environments, each unit is chemical resistant and fire resistant to 960°C. The option to add a selection of auxiliary blocks providing additional contacts and a choice of Neutral assemblies increases the flexibility of the product range. All units have been tested in accordance with IEC/EN60947-3 and UV tested to ISO4892.

Fuse combination units are available on request.

N' = switched neutral (early make, late break) | 'NL' = unswitched neutral

Switch Disconnectors (I-O)								
Image	Rating	Format	Cat No.	Encl. Size	Encl. Material	Encl. Colour	IP Rating	Cable Entries
	32A	3P+N	EDGP00323N	1	Glass Fibre Reinforced Polyester	Light Grey RAL 7035	IP65	Gland Plates
		3P+NL	EDGP00323NL					
	63A	3P+N	EDGP00633N	1	Glass Fibre Reinforced Polyester	Light Grey RAL 7035	IP65	Gland Plates
3P+NL		EDGP00633NL						
80A	3P+N	EDGP00803N	1	Glass Fibre Reinforced Polyester	Light Grey RAL 7035	IP65	Gland Plates	
	3P+NL	EDGP00803NL						
	100A	3P+N	EDGP01003N	2	Glass Fibre Reinforced Polyester	Light Grey RAL 7035	IP65	Gland Plates
		3P+NL	EDGP01003NL					
	125A	3P+N	EDGP01253N	2	Glass Fibre Reinforced Polyester	Light Grey RAL 7035	IP65	Gland Plates
		3P+NL	EDGP01253NL					
	160A	3P+N	EDGP01603N	2	Glass Fibre Reinforced Polyester	Light Grey RAL 7035	IP65	Gland Plates
		3P+NL	EDGP01603NL					
200A	3P+N	EDGP02003N	4	Glass Fibre Reinforced Polyester	Light Grey RAL 7035	IP65	Gland Plates	
	3P+NL	EDGP02003NL						
	250A	3P+N	EDGP02503N	5	Glass Fibre Reinforced Polyester	Light Grey RAL 7035	IP65	Gland Plates
		3P+NL	EDGP02503NL					
	400A	3P+N	EDGP04003N	6	Glass Fibre Reinforced Polyester	Light Grey RAL 7035	IP65	Gland Plates
		3P+NL	EDGP04003NL					
	630A	3P+N	EDGP06303N	7	Glass Fibre Reinforced Polyester	Light Grey RAL 7035	IP65	Gland Plates
		3P+NL	EDGP06303NL					
	800A	3P+N	EDGP08003N	7	Glass Fibre Reinforced Polyester	Light Grey RAL 7035	IP65	Gland Plates
		3P+NL	EDGP08003NL					
	1000A	3P+N	EDGP10003N	7	Glass Fibre Reinforced Polyester	Light Grey RAL 7035	IP65	Gland Plates
		3P+NL	EDGP10003NL					

FIXED LID ACCESSORIES - APPLICABLE FOR PRODUCTS ON PAGES 1-9.

All of the accessories listed below can be retrofitted. One block can be fitted either side of the main assembly on all of the 3 pole Switch-Disconnectors interiors. The option to add a selection of auxiliary blocks or external fixing feet increases the flexibility to our product ranges.

CS Switch Accessories	
Description	Cat. No.
Auxiliary Contact- 2 Early break	SAUX2EB
Auxiliary Contact- 1 N/O + 1 N/C	SAUXCO
25A- 40A Compact Neutral (Unswitched)	SNLC40
63A Neutral (Unswitched)	SNL63
80A Neutral (Unswitched)	SNL80
100A Neutral (Unswitched)	SNL100
25A Neutral (Switched)	SSP25
32A- 40A Neutral (Switched)	SSP40
63A Neutral (Switched)	SSP63
80A Neutral (Switched)	SSP80
100A Neutral (Switched)	SSP100
GA Switch Accessories	
Description	Cat. No.
80A- 100A Auxiliary Contact- 1 Early break	SAUX1EBL
80A- 100A Auxiliary Contact- 1 N/O + 1 N/C	SAUXCOL
80A- 100A Neutral (Unswitched)	SNL100L
80A Neutral (Switched)	SSP80L
100A Neutral (Switched)	SSP100L
K Switch Accessories	
Description	Cat. No.
Auxiliary Contact- 1 N/O + 1 N/C	SAUXKCO
Fixing Feet (for sheet steel only)	
Description	Cat. No.
External Fixing Feet for 20A- 32A	EFA
External Fixing Feet for 40A- 63A	EFB
External Fixing Feet for 80A- 100A	EFC

Auxiliary Contact Block

Data supplied against tests to IEC/BS EN 60947-5-1

Application	Sym.	Category	CS Type	GA Type	K Type
Thermal current	I_{th}		10A	10A	12A
Rated insulation voltage	U_i		690V	1000V	690V
Utilisation category	-	AC15	8A@110V 8A@240V 3A@400V 1A@690V	6A@110V 6A@230V 3A@400V	6A@110V 6A@230V 4A@400V
Max conditions	mm ²		1.5	2.5	2.5
Tightening torque	Nm		0.6	0.8	0.6

HINGED DOOR ACCESSORIES - APPLICABLE FOR PRODUCTS ON PAGES 10-11.

All of the accessories listed below can be retrofitted. One block can be fitted either side of the main assembly on all of the 3 pole Switch-Disconnectors interiors. The option to add a selection of auxiliary blocks increases the flexibility to our product ranges.

All of the Fuse Combination Units are supplied fitted with a set of fully rated IEC/BS EN 60269 (BS88) fuse links. Replacements can be supplied as individual fuse links and can be fitted to a lower rating to suit a particular load: please refer to the rating table below to maintain the correct size/tag format.

Terminal protection is provided on all items for live incoming terminals; spare terminal covers are available for replacement or extending the protection to the outgoing terminals. (Not available for 800A & 1000A Switch Disconnectors.)

Auxiliary Contacts		
Description	Cat. No.	
Auxiliary Contact For 32A- 200A Switch Disconnectors	SAUXCO	
Auxiliary Contact For 32A- 160A Fuse Combination Units	SAUXKITA	
Auxiliary Contact For 250A Switch Disconnectors	SAUXKITB	
Auxiliary Contact For 400A- 800A Switch Disconnectors & 200A- 400A Fuse Combination Units	SAUXKITC	
Auxiliary Contact For 1000A Switch Disconnectors & 630A Fuse Combination Units	SAUXKITD	
Fuse Links		
Description	Bussman Cat. No	Cat. No.
32A Fuse Link. BS Fuse Format A2, A3. Fuse Fixing CRS (mm) 73 nom.	AA032	SFL32
63A Fuse Link. BS Fuse Format A2, A3. Fuse Fixing CRS (mm) 73 nom.	BA063	SFL63
100A Fuse Link. BS Fuse Format A4. Fuse Fixing CRS (mm) 94 nom.	CE0100	SFL100
125A Fuse Link. BS Fuse Format A4. Fuse Fixing CRS (mm) 94 nom.	DE0125	SFL125
160A Fuse Link. BS Fuse Format B1, B2. Fuse Fixing CRS (mm) 111 nom.	DD160	SFL160
200A Fuse Link. BS Fuse Format B1-B2. Fuse Fixing CRS (mm) 111 nom.	DD200	SFL200
250A Fuse Link. BS Fuse Format B1-B2. Fuse Fixing CRS (mm) 111 nom.	ED250	SFL250
315A Fuse Link. BS Fuse Format B1-B4. Fuse Fixing CRS (mm) 111 nom.	ED315	SFL315
400A Fuse Link. BS Fuse Format B1-B4. Fuse Fixing CRS (mm) 111 nom.	ED400	SFL400
630A Fuse Link. BS Fuse Format C1-C3. Fuse Fixing CRS (mm) 133/184 nom.	FF630	SFL630
Terminal Covers		
Description	Cat. No.	
Set of 4 Terminal Covers For 200A Switch Disconnectors & Fuse Combination Units (M8 Stud)	STS1	
Set of 4 Terminal Covers For 250A- 400A Switch Disconnectors & Fuse Combination Units (M10 Stud)	STS2	
Set of 4 Terminal Covers For 630A Fuse Combination Units (M12 Stud)	STS3	
Set of 4 Terminal Covers For 630A Switch Disconnectors (M12 Stud)	STS4	

TECHNICAL SPECIFICATION - APPLICABLE FOR PAGES 1-4 AND 6-9.

Data supplied against tests to IEC/BS EN 60947-3

Fixed Lid Enclosed Switchgear																				
Application	Sym.	Unit	Category	20A	25A		32A		40A			63A			80A		100A			
Interior switch		-		GX20	CS25	K25	CS32	K32	GX32	CS40R	GX40	K40	CS63	GN63	K63	CS80	GA080A	CS100	GA100A	
Rated thermal current	I_{the}	A		20	25	25	32	32	32	40	40	40	63	63	63	80	80	100	100	
Rated insulation voltage	U_i	V		690	690	690	690	690	690	690	690	690	690	690	690	690	1000	1000	1000	
Rated impulse voltage	U_{imp}	kV		6	6	4	6	4	6	6	6	4	6	6	6	6	8	8	8	
Rated operational current	I_e	A	400V AC23A (3 phase AC 50/60Hz)	15	25	25	32	32	32	32	35	40	54	60	63	63	80	100	100	
Rated operational power	I_e	kW	230V	2.2	3.7	3.9	4.8	5	4.8	6.0	6.0	6.0	9.4	-	9.4	-	-	-	-	
	P_e		400V	7.5	11	7.5	15	11	15	15	18.5	15	22	30	22	30	45	59	55	
Rated short time withstand current	I_{cw}	A	1 sec	250	500	500	600	500	800	600	800	800	1300	1600	800	1400	2500	2600	2500	
Max. fuse size for short circuit protection	gG	kA	10kA	20	35	35	35	35	35	40	40	40	80	63	63	80	80	160	100	
			25kA	16	32	32	32	32	35	32	35	32	63	63	50	63	80	160	100	
			50kA	-	32	32	32	32	-	32	-	32	63	63	50	63	80	160	100	
Recommended connecting capacity			Terminal type																	
			mm ²	Flexible cable	2.5 x 2	6	6	6	6	6 x 2	6	6 x 2	6	16	10	16	16	16	25	25
			mm ²	Rigid cable	2.5 x 2	10	10	10	10	10 x 2	10	10 x 2	10	25	16	25	25	25	25	25
			Nm	Tightening torque	1.0	1.2	1.2	1.2	1.2	1.0	1.2	1.0	1.2	1.2	1.2	1.2	1.2	5-6	5	5-6
Operating Temp Range			Ambient	-5°C to +40°C																

TECHNICAL SPECIFICATION - APPLICABLE FOR PAGE 5.

Data supplied against tests to IEC/BS EN 60947-3





1 = Pollution Degree 3
2 = Pollution Degree 2

Single Array Switch Disconnector Units														
Application	Category	Unit	EPV162	PVP164	EPV252	EPV253	PVP254	EPV322	EPV323	PVP324	EPV402	EPV403	PVP404	
Rated thermal current	I_{the}	A	16		25			32			40			
Rated insulation voltage	U_i	V	1,000 ¹		1,000 ¹			1,000 ¹			1,000 ¹			
			1,500 ²		1,500 ²			1,500 ²			1,500 ²			
Rated impulse withstand volt.	U_{imp}	kV	8		8			8			8			
Rated operational current (DC21B)	I_e	300V (A)	16	16	25	25	25	32	32	32	40	40	40	
		400V (A)	16	16	25	25	25	32	32	32	40	40	40	
		600V (A)	16	16	25	25	25	32	32	32	-	40	40	
		800V (A)	16	16	25	25	25	-	32	32	-	40	40	
		1,000V (A)	16	16	16	25	25	-	32	32	-	-	40	
		1,200V (A)	-	16	-	-	20	-	-	25	-	-	32	
1,500V (A)	-	16	-	-	16	-	-	20	-	-	25			
Mechanical life		Ops	15,000		15,000			15,000			15,000			
Rated short-time withstand current	I_{cw}	1s	500		500			500			500			
Short circuit making capacity	I_{cm}	A	550		550			550			550			
Terminal type														
Terminal tightening torque		Nm	1.2		1.2			1.2			1.2			
Conductor size r = rigid f = flexible	Max r/f	2x	mm2	10/6		10/6			10/6			10/6		
			AWG	8/10		8/10			8/10			8/10		
	Min r/f	2x	mm2	1.5/1.5		1.5/1.5			1.5/1.5			1.5/1.5		
			AWG	16/16		16/16			16/16			16/16		

TECHNICAL SPECIFICATION - APPLICABLE FOR PAGE 5.













Data supplied against tests to IEC/BS EN 60947-3

1 = Pollution Degree 3
2 = Pollution Degree 2

Twin Array Switch Disconnecter Units						
Application	Category	Unit	PVP1622	PVP2522	PVP3222	PVP4022
Rated thermal current	I_{the}	A	16	25	32	40
Rated insulation voltage	U_i	V	1,000 ¹	1,000 ¹	1,000 ¹	1,000 ¹
			1,500 ²	1,500 ²	1,500 ²	1,500 ²
Rated impulse withstand volt.	U_{imp}	kV	8	8	8	8
Rated operational current (DC21B)	I_e	300V (A)	16	25	32	40
		400V (A)	16	25	32	40
		600V (A)	16	25	32	-
		800V (A)	16	25	-	-
		1,000V (A)	16	16	-	-
Mechanical life		Ops	15,000	15,000	15,000	15,000
Rated short-time withstand current	I_{cw}	1s	500	500	500	500
Short circuit making capacity	I_{cm}	A	550	550	550	550
Terminal type						
Terminal tightening torque		Nm	1.2	1.2	1.2	1.2
Conductor size	Max r/f	2x mm2	10/6	10/6	10/6	10/6
		AWG	8/10	8/10	8/10	8/10
r = rigid f = flexible	Min r/f	2x mm2	1.5/1.5	1.5/1.5	1.5/1.5	1.5/1.5
		AWG	16/16	16/16	16/16	16/16















TECHNICAL SPECIFICATION - APPLICABLE FOR PAGE 11.

Data supplied against tests to IEC/BS EN 60947-3

GRP Switch Disconnectors (O-I)																
Application	Sym	Unit	Category	32	63	80	100	125	160	200	250	400	630	800	1000	
Rated thermal current	I_{the}	A		32	63	80	100	125	160	200	250	400	630	720	1000	
Rated insulation voltage	U_i	V		690	690	690	1000	1000	1000	1000	1000	1000	1000	1000	1000	
Rated impulse voltage	U_{imp}	kV		6	6	6	8	8	8	8	12	12	12	12	8	
Rated operational current (AC)	I_e	A	400V AC21A	32	63	80	100	125	160	200	250*	400*	630*	800*	1000*	
			690V AC21A	32	63	80	100	125	160	200	250	400	630	800	1000	
			400V AC22A	-	-	-	100	125	160	200	250*	400*	630*	800*	1000*	
			690V AC22A	-	-	-	100	125	160	160	250	400	630	800	-	
			400V AC23A	29	48	56	100	112	128	128	250*	400*	630*	720*	1000	
			690V AC23A	17	33	33	-	-	-	-	250	350	350	350	-	
Rated operational current (DC) (/poles in series)	I_e	A	Up to 48V DC21A	32/1	63/1	80/1	-	-	-	-	250/2	400/2	630/1	800/1	1000/1	
			220V DC21A	32/3	63/4	80/4	-	-	-	-	250/2	400/2	630/2	800/2	1000/3	
			Up to 48V DC22A	-	-	-	-	-	-	-	250/2	400/1	630/1	800/1	-	
			220V DC22A	-	-	-	-	-	-	-	250/2	400/2	630/2	800/2	-	
			Up to 48V DC23A	-	-	-	-	-	-	-	250/2	400/1	630/1	800/1	-	
			220V DC23A	-	-	-	-	-	-	-	250/2	400/2	630/2	630/2	-	
Rated operational power	P_e	kW	400/415V AC23A	15	25	30	59	63	75	75	132	200	315	355	400	
			690V AC23A	15	30	30	51	55	55	55	200	315	355	355	-	
Short circuit making capacity	I_{cm}	kA	Peak value	1.4	2.9	3.0	3.7	4.0	5.0	5.0	35	65	80	80	105	
Short circuit withstand (1sec)	I_{cw}	kA	rms value	0.6	1.3	1.4	2.6	2.8	3.0	3.0	8	17	17	17	50	
Min. mechanical endurance	-	-	Operations (10 ³)	250	250	250	50	50	50	50	16	10	10	10	6	
Min. electrical endurance	-	-	415V at 0.65 pf	-	-	-	-	-	-	-	1,000	1,000	500	500	500	
Connecting capacity	-	-	Terminal type													
	mm ²	mm ²	Min/Max	2.5/10	2.5/25	2.5/25	-/70	-/70	-/70	-/95	120	2x150	2x185	2x240	2x300	
	mm	mm	Stud/Cu palm width	-	-	-	-	-	-	-	8x25	10x30	10x30	12x40	12x40	12x60
	Nm	Nm	Tightening torque	1.2	1.2	1.2	5	5	5	10	30	30	50	50	50	



















TECHNICAL SPECIFICATION - APPLICABLE FOR PAGES 10-11.

Data supplied against tests to IEC/BS EN 60947-3. * All AC21, AC22 & AC23 tests carried out at 415V.

Sheet Steel Switch Disconnectors (O-I)																			
Application	Sym	Unit	Category	32	63		80	100	125	160	200	250	400	630	800	1000	1250		
				3P	3P	6P	3P	3P	3P	3P	3P/6P	3P/6P	3P	3P	3P	3P	3P	3P	
Rated thermal current	I _{the}	A		32	63	63	80	100	125	160	200	250	400	630	720	1000	1250		
Rated insulation voltage	U _i	V		690	690	690	690	1000	1000	1000	1000	1000	1000	1000	1000	1000	1000		
Rated impulse voltage	U _{imp}	kV		6	6	6	6	8	8	8	8	12	12	12	12	8	8		
Rated operational current (AC)	I _e	A	400V AC21A	32	63	63	80	100	125	160	200	250*	400*	630*	800*	1000*	1250*		
			690V AC21A	32	63	63	80	100	125	160	200	250	400	630	800	1000	1250		
			400V AC22A	-	-	-	-	100	125	160	200	250*	400*	630*	800*	1000*	1250*		
			690V AC22A	-	-	-	-	100	125	160	160	250	400	630	800	-	-		
			400V AC23A	29	48	48	56	105	111	132	132	250*	400*	630*	720*	1000*	1000*		
			690V AC23A	17	33	33	33	-	-	-	-	250	350	350	350	350	-	-	
Rated operational current (DC) (/poles in series)	I _e	A	Up to 48V DC21A	32/1	63/1	63/1	80/1	-	-	-	-	250/2	400/2	630/1	800/1	1000/1	1250/1		
			220V DC21A	-	-	-	-	-	-	-	-	250/2	400/2	630/2	800/2	1000/3	1250/3		
			Up to 48V DC22A	-	-	-	-	-	-	-	-	250/2	400/1	630/1	800/1	-	-		
			220V DC22A	-	-	-	-	-	-	-	-	250/2	400/2	630/2	800/2	-	-		
			Up to 48V DC23A	-	-	-	-	-	-	-	-	250/2	400/1	630/1	800/1	-	-		
			220V DC23A	-	-	-	-	-	-	-	-	250/2	400/2	630/2	630/2	-	-		
Rated operational power	P _e	kW	400/415V AC23A	15	25	25	30	59	63	75	75	132	200	315	355	400	500		
			690V AC23A	15	30	30	30	51	55	55	55	200	315	355	355	-	-		
Short circuit making capacity	I _{cm}	kA	Peak value	1.4	2.9	2.9	3.0	3.7	4.0	5.0	5.0	35	65	80	80	105	105		
Short circuit withstand (1sec)	I _{cw}	kA	rms value	0.6	1.3	1.3	1.4	2.6	2.8	3.0	3.0	8	17	17	17	50	50		
Min. mechanical endurance	-	-	Operations (10 ³)	250	250	500	250	50	50	50	50	16	10	10	10	6	6		
Min. electrical endurance	-	-	415V at 0.65 pf	-	-	-	-	-	-	-	-	1,000	1,000	500	500	500	500		
Connecting capacity	-	mm ²	Terminal type																
			Min/Max	2.5 / 10	2.5 / 25	2.5 / 25	2.5 / 25	2.5 / 35	2.5 / 70	2.5 / 70	-/95	150	2 x 150	2 x 185	2 x 240	2 x 300	2 x 300	3 x 300	
			Stud/Cu palm width	-	-	-	-	-	-	-	-	8 x 25	10 x 30	10 x 30	12 x 40	12 x 40	12 x 40	12 x 60	12 x 60
			Tightening torque	1.2	1.2	1.2	1.2	5	5	5	10	30	30	50	50	50	50	50	50

TECHNICAL SPECIFICATION - APPLICABLE FOR PAGES 10-11.

Data supplied against tests to IEC/BS EN 60947-3. * All AC21, AC22 & AC23 tests carried out at 415V.

Sheet Steel Fuse Combination Units (O-I)															
Application	Sym	Unit	Category	32	63	100	125	160	200	250	315	400	630	800	
Rated thermal current	I_{the}	A		32	63	100	125	160	200	250	315	400	630	800	
Rated insulation voltage	U_i	V		750	750	750	750	750	1000	1000	1000	1000	1000	1000	
Rated impulse voltage	U_{imp}	kV		12	12	12	12	12	12	12	12	12	12	12	
Rated operational current	AC	I_e	A	415V AC23A	32	63	100	125	160	200	250	315	400	630	720
	DC		A	220V DC23A	-	-	100/4	100/4	100/4	200/3	250/3	315/3	400/3	630/3	800/3
Rated making capacity (AC23A)		A	415V, 0.35 pf	320	630	1,000	1,250	1,600	2,000	2,500	3,150	4,000	6,300	8,000	
Rated breaking capacity (AC23A)		A	415V, 0.35 pf	256	504	800	1,000	1,280	1,600	2,000	2,520	3,200	5,040	5,760	
Rated conditional (fused) short circuit	kA	kA	S/C current rms	80	80	80	80	80	80	80	80	80	80	80	
	A	A	back-up fuse gG	32	63	100	125	160	200	250	315	400	630	800	
Min. mechanical endurance		-	Operations	25000	25000	15000	15000	15000	10000	10000	10000	10000	10000	10000	
Min. electrical endurance		-	415V at 0.65 pf	1,500	1,500	1,000	1,000	1,000	1,000	1,000	1,000	1,000	1,000	1,000	
BS fuse format				A3	A3	A4	A4	B1, B2	B1, B2	B1, B2	B1, B4	B1, B4	C1, C3	C1, C3	
Connecting capacity		-	Terminal type												
		mm ²	Min/Max	16	25	95	95	120	150	185	240	300	400	400	
		mm	Stud/Cu palm width	-	-	8x20	8x20	8x20	10x25	10x25	10x25	10x25	12x50	12x50	
		Nm	Tightening torque	2.5	2.5	10	10	10	30	30	30	30	50	50	
Sheet Steel Changeover Switch Disconnectors (I-O-II)															
Application	Sym	Unit	Category	63	100	125	160	200	250	400	630				
Rated thermal current	I_{the}	A		63	100	125	160	200	250	400	630				
Rated insulation voltage	U_i	V		750	750	1000	1000	1000	1000	1000	1000				
Rated impulse voltage	U_{imp}	kV		6	6	6	6	6	12	12	12				
Rated operational current	I_e	A	415V AC22A	63	100	125	160	200	250	400	630				
Rated making capacity (AC23A)		A	415V, 0.35 pf	630	630	1,250	1,600	2,000	2,500	4,000	6,300				
Rated breaking capacity (AC23A)		A	415V, 0.35 pf	504	504	1,000	1,280	1,600	2,000	3,200	5,040				
Short circuit current		kA	rms (with fuses)	80	80	80	80	80	100	100	80				
Rated S/C making capacity		kA	Peak	15	15	20	20	20	30	40	50				
Min. mechanical endurance		-	Operations	20,000	20,000	10,000	10,000	10,000	10,000	10,000	10,000				
Min. electrical endurance		-	415V at 0.65 pf	2,500	1,500	1,000	1,000	1,000	1,000	1,000	500				
Connecting capacity		-	Terminal type												
		mm ²	Max	35	35	95	95	95	240	300	400				
		mm	Stud/Cu palm width	6/12	6/12	8/22	8/22	8/22	10/25	10/25	12/50				
		Nm	Tightening torque	3	3	10	10	10	30	30	50				

DIE-CAST ALUMINIUM

Size A

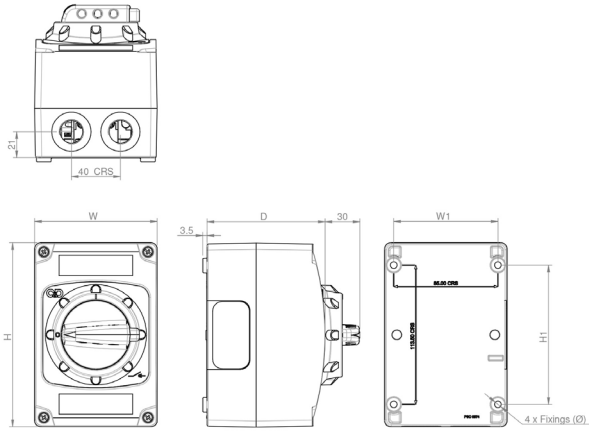

Size B

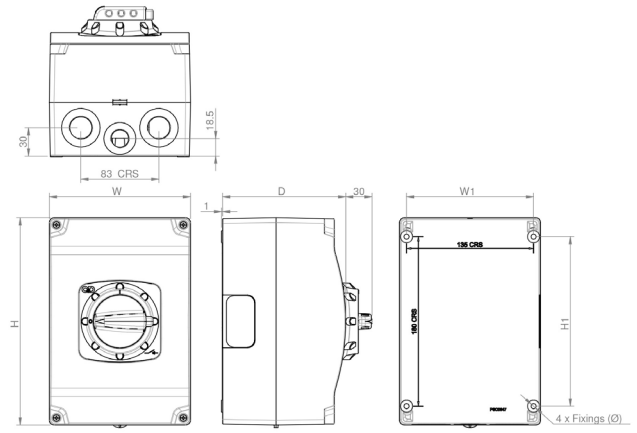

Size C

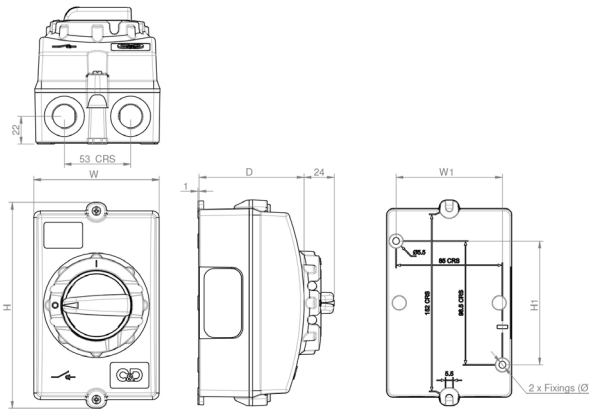

Encl. Size	Overall Dims.			Fixing Details		
	H	W	D	H1	W1	Ø
A	150	100	96	113.5	85	5.5
B	220	150	120	180	135	5.5
C	164	100	84.5	98.5	85	5.5

MOULDED PLASTIC

Size A

Size B

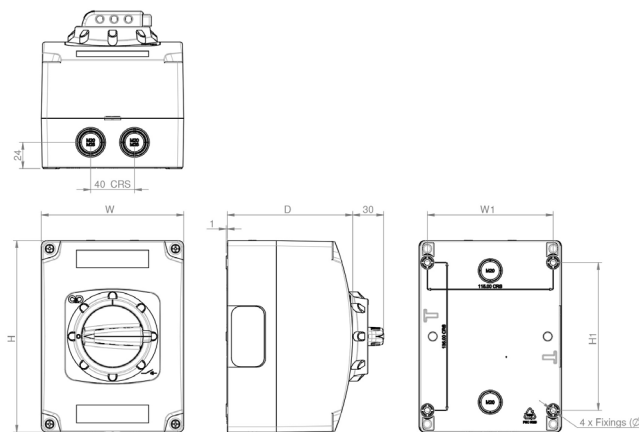
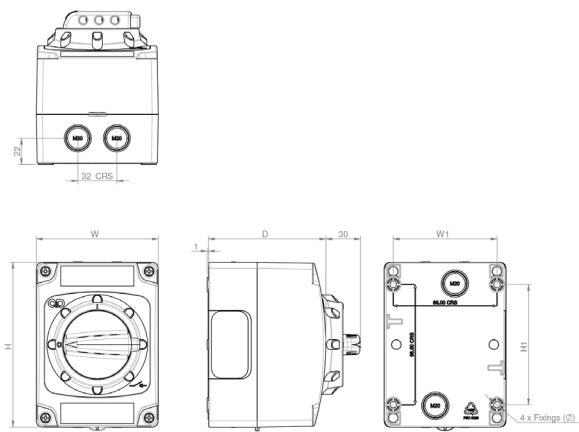

Sizes C & D

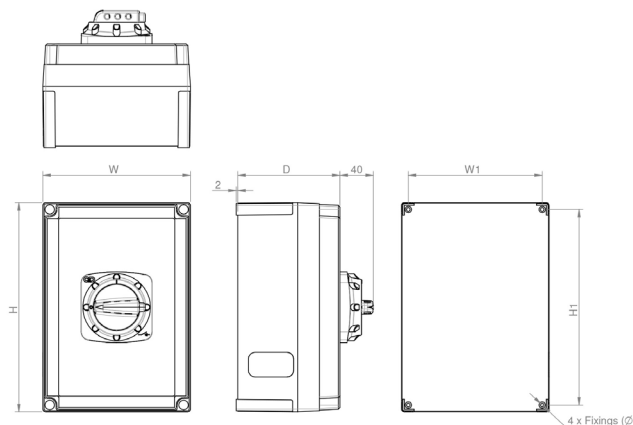

Size EA

Size EB

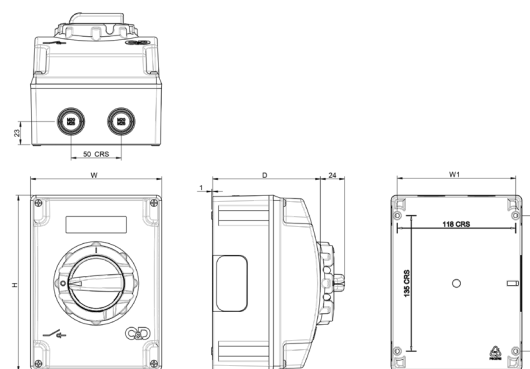
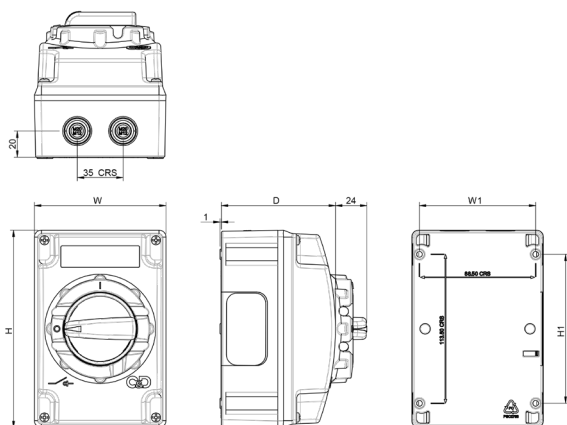

Encl. Size	Overall Dims.			Fixing Details		
	H	W	D	H1	W1	Ø
A	135	100	95	98.5	85	5.5
B	175	130	115	135	115	5.5
C	255	180	125	238.5	163.5	4.5
D	255	180	175	238.5	163.5	4.5
E	149	100	108.5	136.5 / 98.5	85	5.5
EA	150	100	87	113.5	88.5	
EB	130	175	107	135	118	

PHOTOVOLTAIC (PV)

Size B

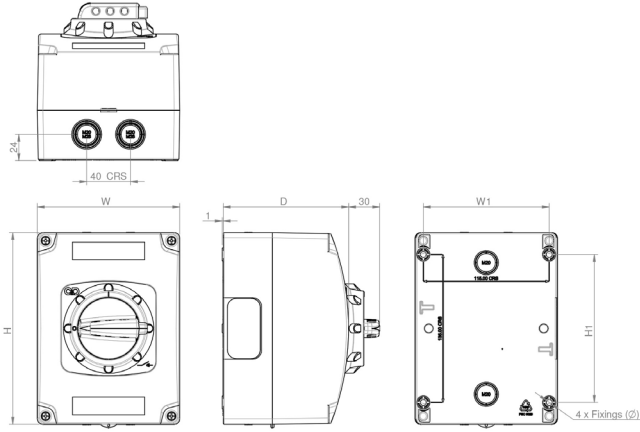

Size E

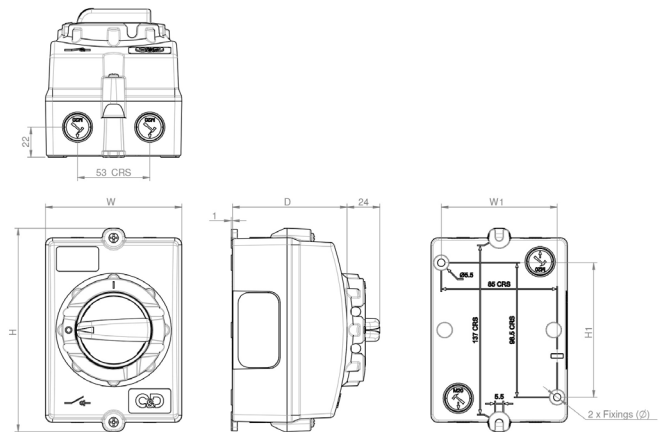

Size A with Flying Leads

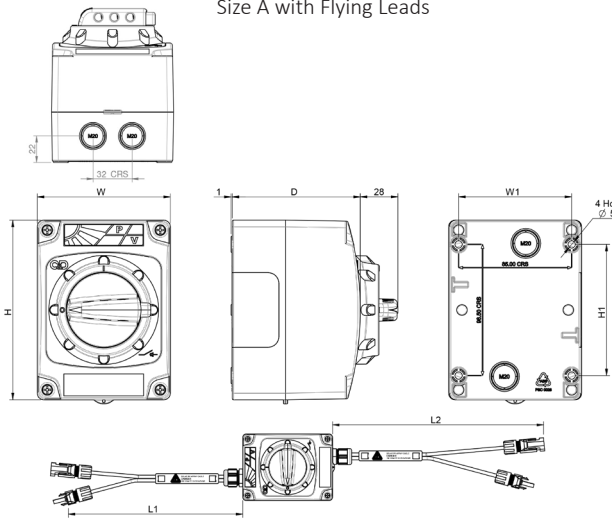

Size E with Flying Leads

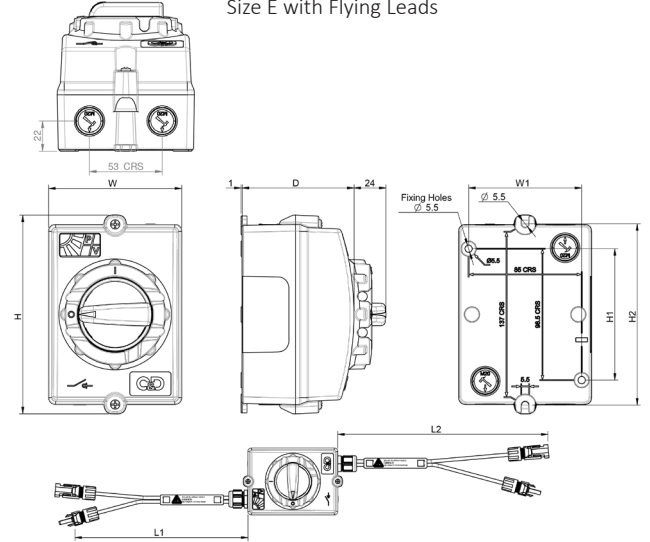

Size A with MC4 Connectors

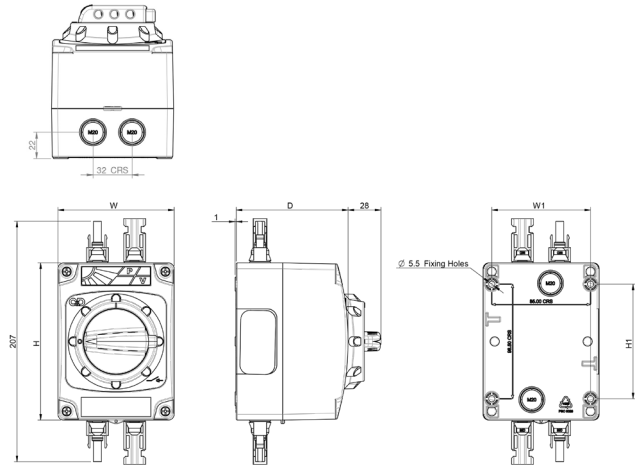

Size E with MC4 Connectors

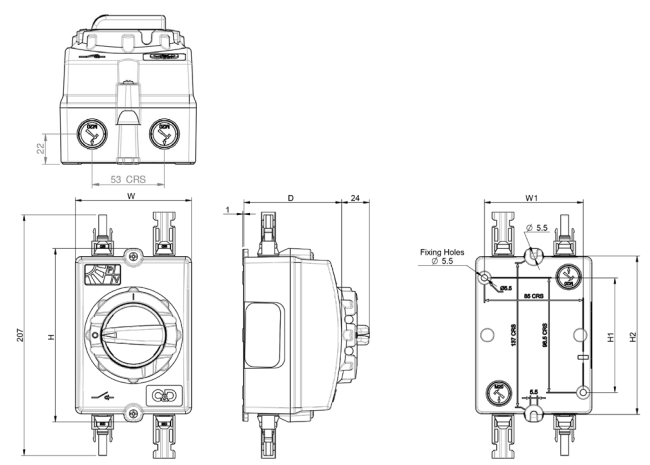

Encl. Size	Overall Dims.					Fixing Details		
	H	W	D	L1	L2	H1	W1	Ø
B	175	130	115	-	-	135	115	5.5
E	149	100	108.5	-	-	136 / 98.5	85	5.5
A with flying leads	135	100	96	300	500	98.5	85	5.5
E with flying leads	135	100	84	300	500	136 / 98.5	85	5.5
A with MC4	135	100	96	-	-	98.5	85	5.5
E with MC4	135	100	84	-	-	136 / 98.5	85	5.5

SHEET STEEL & STAINLESS STEEL

Size A - C

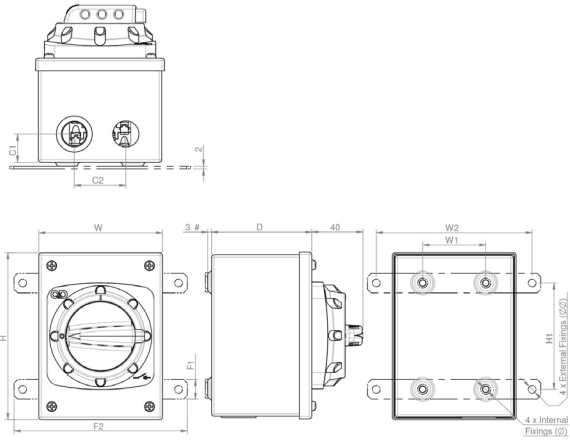

Encl. Size	Overall Dims.		
	H	W	D
A	135	100	80
B	175	130	100
C	310	200	100

Encl. Size	Fixing Details					
	W1	W2	F1	F2	Ø	ØØ
A	51	126	16	140	5.5	6.35
B	81	155	16	178	5.5	6.35
C	146	228	20	249	5.5	6.35

*Stainless Steel enclosures are supplied without dimples to allow flush mounting

SLOPING ROOF

Size A & B

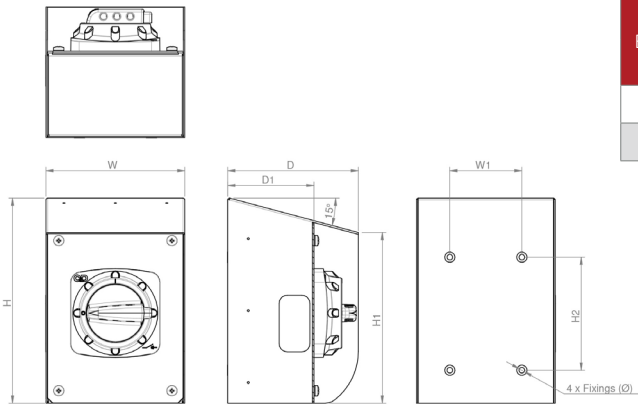

Encl. Size	Overall Dims.			Fixing Details				
	H	W	D	H1	H2	W1	D1	Ø
A	200	135	127	165	110	70	80	5.5
B	240	185	147	200	130	90	100	5.5

FLUSH MOUNTING

Size A - C

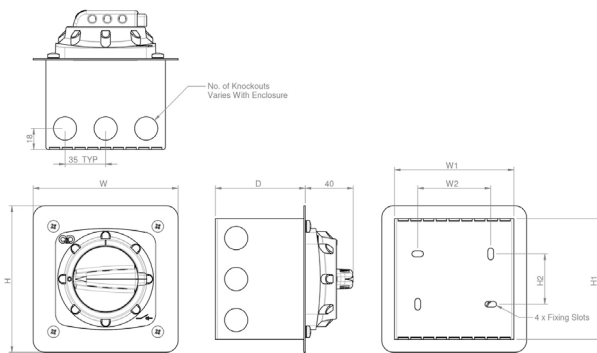

Size D & E

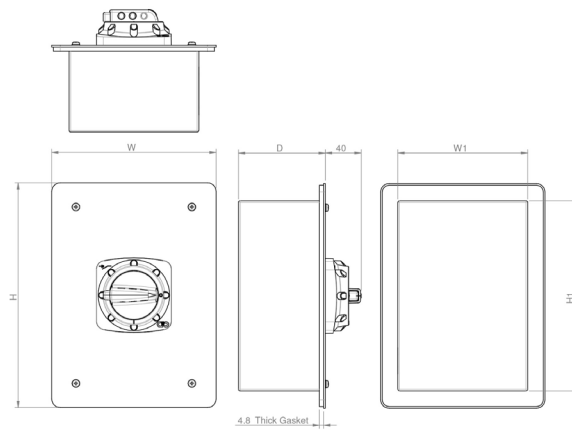

Encl. Size	Overall Dims.			Fixing Details			
	H	W	D	H1	H2	W1	W2
A	125	125	75	100	43	100	62
B	175	175	75	150	93	150	113
C	175	175	100	150	93	150	113
D	260	190	97-101	220	--	150	--
E	320	260	126-130	280	--	220	--

SHEET STEEL HINGED DOOR

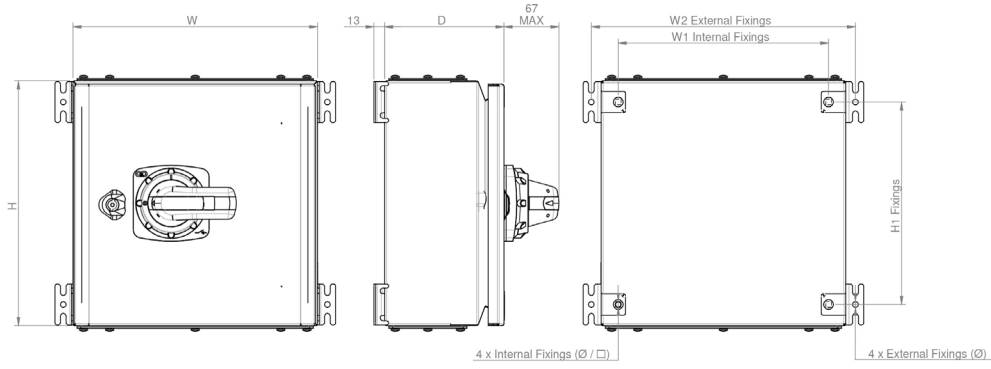

Encl. Size	Overall Dims.			Fixing Details			
	H	W	D	H1	W1	W2	Ø
1	300	300	150	248	258	324	7
2	300	300	200	248	258	324	7
3	400	300	150	348	258	324	7
4	400	300	200	348	258	324	7
5	400	400	200	348	358	424	7
6	500	400	200	448	358	424	7
7	600	400	200	548	358	424	7
8	600	400	300	548	358	424	7
9	600	500	200	548	458	524	7
10	700	500	300	648	458	524	7
11	800	600	200	748	558	624	7
12	800	600	300	748	558	624	7
13	1000	600	300	948	558	624	7
14	1000	800	300	948	758	824	7

GRP HINGED DOOR

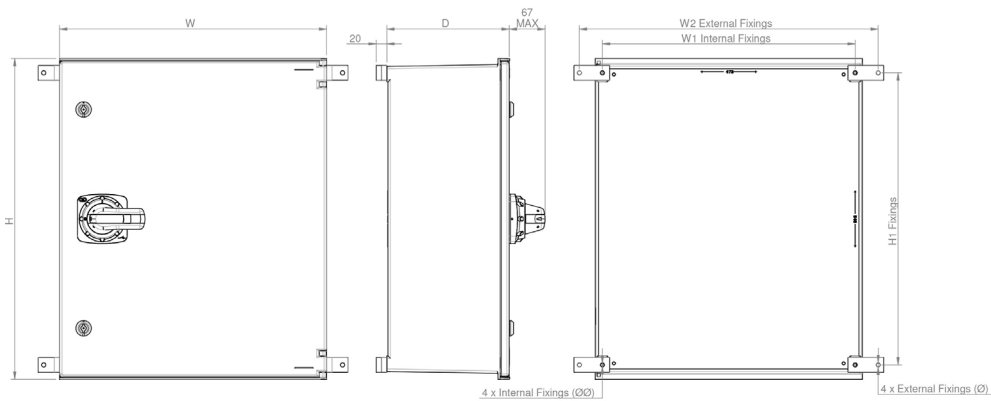

Encl. Size	Overall Dims.			Fixing Details			
	H	W	D	H1	W1	W2	Ø
1	300	250	140	250	223	310	9
2	400	300	200	348	273	360	9
4	600	400	230	546	373	460	9
5	600	500	230	546	473	560	9
6	800	600	300	744	573	660	9
7	1056	852	350	940	750	885	8.5

FIRE RATED SWITCHGEAR

Craig & Derricott offer one of the most extensive range of Fire Rated Switchgear in the market.

Available 20A to 1250A, this switchgear is used to maintain power to vital equipment such as smoke extraction / ventilation fans allowing the safe evacuation of businesses, car parks and public areas in the event of a fire. These Switch Disconnectors are installed near to the extraction fan for isolation purposes, and have been tested in conjunction with the fan equipment to meet the stringent thermal requirements of BS EN 12101-3. Within BS EN 12101-3 (smoke and heat controls) there are different classes of duty which define a specific temperature gradient, upper temperature limit and time period.

- F400 products can withstand 400°C for 2 hours
- F200 products can withstand 200°C for 2 hours



F200 FIRE RATED SWITCHGEAR

The F200 Fire Rated products range is designed for installations where the supply must be maintained for 2 hours at 200°C.

Ranging from 20A to 200A, these units are supplied in IP66/65 Die-Cast Aluminium or IP65 Sheet Steel enclosures. All units come standard in a Traffic Red (RAL 3020) polyester powder coat finish, with padlocking in both 'Off' and 'On' positions.

'N' = switched neutral (early make, late break) | 'NL' = unswitched neutral | 'EB' = 2 N/O early break auxiliary contacts
'T' = Increased terminal capacity



Switch Disconnectors (O-I)

Image	Rating	Format	Cat No.	Encl. Size	Encl. Material	Encl. Colour	IP Rating	Cable Entries			
	20A	6P	F2SDDR206	A	Die-Cast Aluminium	Traffic Red RAL 3020	IP66	1xM20 +1xM25 Top & Btm			
		6P+2EB Aux	F2SDDR206EB								
	25A	2P	F2SDDR252	A	Die-Cast Aluminium	Traffic Red RAL 3020	IP66	1xM20 +1xM25 Top & Btm			
		3P	F2SDDR253								
		3P+N	F2SDDR253N								
		3P+NL	F2SDDR253NL								
		3P+2EB Aux	F2SDDR253EB								
	32A	2P	F2SDDR322	A	Die-Cast Aluminium	Traffic Red RAL 3020	IP66	1xM20 +1xM25 Top & Btm			
		3P	F2SDDR323								
		3P+N	F2SDDR323N								
		3P+NL	F2SDDR323NL								
		40A	3P+2EB Aux	F2SDDR323EB	A	Die-Cast Aluminium	Traffic Red RAL 3020	IP66	1xM20 +1xM25 Top & Btm		
2P			F2SDDR402								
3P			F2SDDR403								
3P+N			F2SDDR403N								
3P+NL			F2SDDR403NL								
40A		3P+2EB Aux	F2SDDR403EB	B	Die-Cast Aluminium	Traffic Red RAL 3020	IP65	2xM25 Top & Btm			
		2P	F2SDDR402T								
		3P	F2SDDR403T								
		3P+N	F2SDDR403NT								
		3P+NL	F2SDDR403NLT								
	3P+2EB Aux	F2SDDR403EBT									
63A	6P	F2SDDR406	B	Die-Cast Aluminium	Traffic Red RAL 3020	IP65	2xM25 Top & Btm + 1xM20 Btm				
	6P+2EB Aux	F2SDDR406EB									
	2P	F2SDDR632					B	Die-Cast Aluminium	Traffic Red RAL 3020	IP65	2xM32 Top & Btm
	3P	F2SDDR633									
	3P+N	F2SDDR633N									
3P+NL	F2SDDR633NL										
80A	3P+2EB Aux	F2SDDR633EB	B	Die-Cast Aluminium	Traffic Red RAL 3020	IP65	2xM32 Top & Btm				
	3P	F2SDDR803									
	3P+NL	F2SDDR803N									
	3P+2EB Aux	F2SDDR803NL									
	63A	3P+N	F2SDRC00633N	1	Sheet Steel	Traffic Red RAL 3020	IP65	Gland Plates Top & Btm			
		3P+NL	F2SDRC00633NL								
		6P	F2SDRC00636								
	80A	3P+N	F2SDRC00803N	1	Sheet Steel	Traffic Red RAL 3020	IP65	Gland Plates Top & Btm			
		3P+NL	F2SDRC00803NL								
		6P	F2SDRC00806								
	100A	3P+N	F2SDRC01003N	2	Sheet Steel	Traffic Red RAL 3020	IP65	Gland Plates Top & Btm			
		3P+NL	F2SDRC01003NL								
	125A	3P+N	F2SDRC01253N	2	Sheet Steel	Traffic Red RAL 3020	IP65	Gland Plates Top & Btm			
		3P+NL	F2SDRC01253NL								
	160A	3P+N	F2SDRC01603N	2	Sheet Steel	Traffic Red RAL 3020	IP65	Gland Plates Top & Btm			
		3P+NL	F2SDRC01603NL								
200A	3P+N	F2SDRC02003N	3	Sheet Steel	Traffic Red RAL 3020	IP65	Gland Plates Top & Btm				
	3P+NL	F2SDRC02003NL									

TECHNICAL SPECIFICATION

Data supplied against tests to IEC/BS EN 60947-3

F200 Fire Rated Switchgear																
Application	Sym.	Unit	Category	20A	25A	32A	40A			63A	80A	100A	125A	160A	200A	
Switch product range	-	-		GX20	CS25	CS32	GX40	CS40	CS40R	CS63	CS80	CS100	CS125	CS160	CS200	
Rated thermal current	I_{the}	A		20	25	32	40	40	40	63	80	100	125	160	200	
Rated insulation voltage	U_i	V		690	690	690	690	690	690	690	690	1000	1000	1000	1000	
Rated impulse voltage	U_{imp}	kV		6	6	6	6	6	6	6	6	8	8	8	8	
Rated operational power (3 phase AC)		kW	400V / 415V AC23	7.5	11	15	18.5	18.5	15	25	30	59	63	75	75	
			690V AC23	7.5	15	15	15	22	15	30	30	51	55	55	55	
Rated short time withstand current (1 sec)	I_{cw}	A		250	500	600	800	1100	600	1300	1400	2600	2800	3000	3000	
Max. fuse size for short circuit protection (gG Characteristic)		kA	10kA	20	35	35	40	80	40	80	80	160	160	160	200	
			25kA	16	32	35	35	80	32	63	63	160	160	160	160	
			50kA	-	32	32	-	80	32	63	63	160	160	160	160	
Recommended connecting capacity		-	Terminal type													
			mm ² Flexible cable	2.5 x 2	6	6	6 x 2	16	6	16	16	16	25	50	50	70
			mm ² Rigid cable	2.5 x 2	10	10	10 x 2	25	10	25	25	25	50	70	70	95
			Nm Tightening torque	1.0	1.2	1.2	1.0	1.2	1.2	1.2	1.2	1.2	2/5	2/5	2/5	12

DIMENSIONS

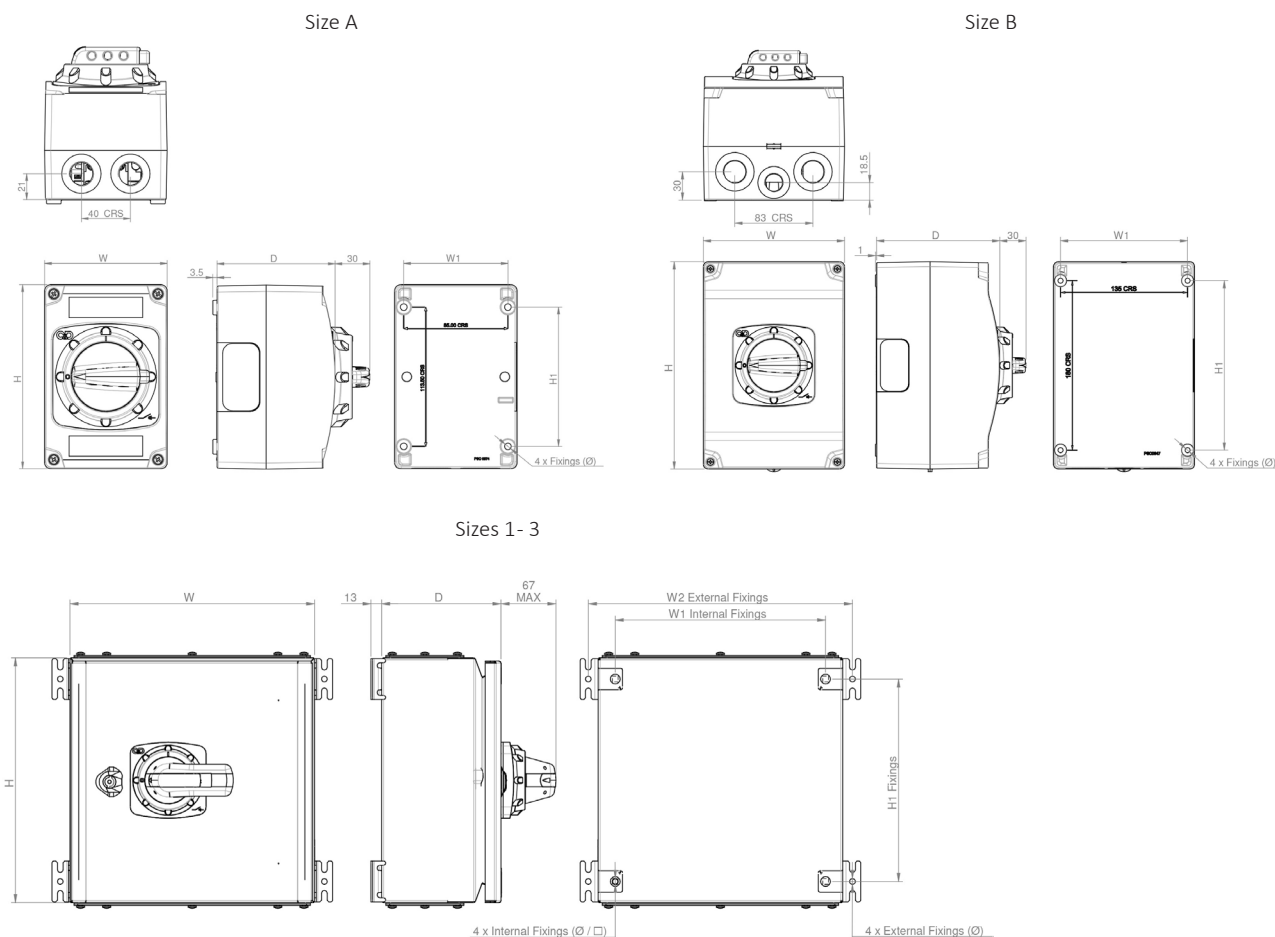

Encl. Size	Overall Dims.			Fixing Details			
	H	W	D	H1	W1	W2	Ø
A	150	100	96	113.5	85	--	5.5
B	220	150	120	180	135	--	5.5
1	300	300	150	248	258	324	7
2	300	300	200	248	258	324	7
3	400	300	150	348	258	324	7

F400 FIRE RATED SWITCHGEAR

The 20A to 1250A F400 Fire Rated product range is supplied in either an IP65 Die-Cast Aluminium enclosure or a hinged door Sheet Steel enclosure, coated in a protective Traffic Red (RAL3020) powder coat finish. The Die-Cast Aluminium products, 20A-63A, are fitted with a black powder coated Die-Cast Aluminium handle while the Sheet Steel enclosed products, 63A and above, are fitted with a highly durable aluminium operating handle. All units from this range feature the ability to be padlocked in both the OFF and ON positions as standard.

The interior switches are constructed from a high temperature grade thermoset material, designed specifically for installations where the supply must be maintained for 2 hours at 400°C. Units rated 32A and above are suitable for enhanced fire rated cables. Stainless Steel 316L enclosures are available on request for the hinged door Sheet Steel product range. Replace 'R' with 'S' in the catalogue number, e.g. F400SDS0633N.

Factory fitted auxiliaries on the 20A-63A Die-Cast range, and 63A-125A hinged door Sheet Steel range are fully rated and fire rated to F400. Non-fire rated auxiliaries are available for the 160A-1250A hinged door Sheet Steel products on request, add '/AUX' to the catalogue number, e.g. F400SDR01604/AUX

'N' = switched neutral (early make, late break) | 'NL' = unswitched neutral | 'EB' = 2 N/O early break auxiliary contacts

When using enhanced fire resistant power cables, please check gland sizes to suit the required product.



Switch Disconnectors (O-I)									
Image	Rating	Format	Cat No.	Encl. Size	Encl. Material	Encl. Colour	IP Rating	Cable Entries	Cert. No.
	20A	2P	F400DDR00202	FA	Die-Cast Aluminium	Traffic Red RAL 3020	IP65	1xM20+1xM25 Top & Btm	C9874/20
		3P	F400DDR00203						
		3P+NL	F400DDR00203NL						
		4P	F400DDR00204						
		3P+2EB	F400DDR00203EB						
		4P+2EB	F400DDR00204EB						
		6P	F400DDR00206						
		8P	F400DDR00208						
	6P+2EB	F400DDR00206EB					1xM20+1xM25 Top & Btm+1xM20 Rhs		
	25A	2P	F400DDR00252	FA	Die-Cast Aluminium	Traffic Red RAL 3020	IP65	1xM20+1xM25 Top & Btm	C9874/20
		3P	F400DDR00253						
		3P+NL	F400DDR00253NL						
		4P	F400DDR00254						
		3P+2EB	F400DDR00253EB						
		4P+2EB	F400DDR00254EB						
		6P	F400DDR00256						
		8P	F400DDR00258						
	6P+2EB	F400DDR00256EB					1xM20+1xM25 Top & Btm+1xM20 Rhs		
	32A	2P	F400DDR00322	FA	Die-Cast Aluminium	Traffic Red RAL 3020	IP65	1xM20+1xM25 Top & Btm	C9874/20
		3P	F400DDR00323						
		3P+NL	F400DDR00323NL						
		4P	F400DDR00324						
		3P+2EB	F400DDR00323EB						
		4P+2EB	F400DDR00324EB						
		6P	F400DDR00326						
		8P	F400DDR00328						
	6P+2EB	F400DDR00326EB					1xM20+1xM25 Top & Btm+1xM20 Rhs		
	40A	2P	F400DDR00402	FA	Die-Cast Aluminium	Traffic Red RAL 3020	IP65	1xM20+1xM25 Top & Btm	C9874/20
		3P	F400DDR00403						
		3P+NL	F400DDR00403NL						
		4P	F400DDR00404						
		3P+2EB	F400DDR00403EB						
		4P+2EB	F400DDR00404EB						
		6P	F400DDR00406						
		8P	F400DDR00408						
	6P+2EB	F400DDR00406EB					1xM20+1xM25 Top & Btm+1xM20 Rhs		
	40A	2P	F400DDR0040T2	FB	Die-Cast Aluminium	Traffic Red RAL 3020	IP65	2xM25 Top & Btm	C9874/20-2
		3P	F400DDR0040T3						
		3P+NL	F400DDR0040T3NL						
		3P+2EB	F400DDR0040T3EB						
		4P	F400DDR0040T4						
		4P+2EB	F400DDR0040T4EB						
		6P	F400DDR0040T6						
		8P	F400DDR0040T8						
	6P+2EB	F400DDR0040T6EB					2xM25 Top & Btm + 1xM20 Btm		

Switch Disconnectors (O-I)

Image	Rating	Format	Cat. No.	Encl. Size	Encl. Material	Encl. Colour	IP Rating	Cable Entries	Cert. No.				
	63A	2P	F400DDR00632	FB	Die-Cast Aluminium	Traffic Red RAL 3020	IP65	2xM32 Top & Btm	C9874/20-2				
		3P	F400DDR00633										
		3P+NL	F400DDR00633NL										
		3P+2EB	F400DDR00633EB										
		4P	F400DDR00634										
		4P+2EB	F400DDR00634EB										
		8P	F400DDR00638										
	63A	2P	F400SDR00632	F1	Sheet Steel	Traffic Red RAL 3020	IP65	Removable Gland Plates Top & Btm	C9874/20-3				
		3P	F400SDR00633										
		3P+NL	F400SDR00633NL										
		3P+2EB	F400SDR00633EB										
		4P	F400SDR00634										
		4P+2EB	F400SDR00634EB										
		6P	F400SDR00636										
		8P	F400SDR00638										
	80A	2P	F400SDR00802	F2	Sheet Steel	Traffic Red RAL 3020	IP65	Removable Gland Plates Top & Btm	C9874/20-4				
		3P	F400SDR00803										
		3P+NL	F400SDR00803NL										
		3P+2EB	F400SDR00803EB										
		4P	F400SDR00804	F4					Sheet Steel	Traffic Red RAL 3020	IP65	Removable Gland Plates Top & Btm	C9874/20-9
		4P+2EB	F400SDR00804EB										
		6P	F400SDR00806										
		6P+2EB	F400SDR00806EB										
	125A	2P	F400SDR01252	F4	Sheet Steel	Traffic Red RAL 3020	IP65	Removable Gland Plates Top & Btm	C9874/20-9				
		3P	F400SDR01253										
		3P+NL	F400SDR01253NL										
		3P+2EB	F400SDR01253EB										
		4P	F400SDR01254										
		6P	F400SDR01256										
		6P+2EB	F400SDR01256EB										
	160A	3P	F400SDR01603	F5	Sheet Steel	Traffic Red RAL 3020	IP65	Removable Gland Plates Top & Btm	C9874/20-6				
		3P+NL	F400SDR01603NL	F7									
		4P	F400SDR01604										
	200A	6P	F400SDR01606	F5	Sheet Steel	Traffic Red RAL 3020	IP65	Removable Gland Plates Top & Btm	C9874/20-6				
		3P	F400SDR02003										
		3P+NL	F400SDR02003NL										
	250A	4P	F400SDR02004	F5	Sheet Steel	Traffic Red RAL 3020	IP65	Removable Gland Plates Top & Btm	C9874/20-6				
		6P	F400SDR02006										
		3P	F400SDR02503										
		315A	3P+NL	F400SDR02503NL	F5	Sheet Steel	Traffic Red RAL 3020	IP65	Removable Gland Plates Top & Btm	C9874/20-6			
			4P	F400SDR02504									
			6P	F400SDR02506									
400A		3P	F400SDR03153	F6	Sheet Steel	Traffic Red RAL 3020	IP65	Removable Gland Plates Top & Btm	C9874/20-7				
		3P+NL	F400SDR03153NL										
		4P	F400SDR03154										
630A		3P	F400SDR04003	F6	Sheet Steel	Traffic Red RAL 3020	IP65	Removable Gland Plates Top & Btm	C9874/20-7				
		3P+NL	F400SDR04003NL										
		4P	F400SDR04004										
1250A		3P	F400SDR06303	F8	Sheet Steel	Traffic Red RAL 3020	IP65	Removable Gland Plates Top & Btm	C9874/20-7				
		3P+NL	F400SDR06303NL										
		4P	F400SDR06304										
1250A	3P	F400SDR12503	F9	Sheet Steel	Traffic Red RAL 3020	IP65	Removable Gland Plates Top & Btm	C9813/19-3					
	3P+NL	F400SDR12503NL											

TECHNICAL SPECIFICATION

Data supplied against tests to IEC/BS EN 60947-3. * 63A in Die-Cast Aluminium enclosure = 16mm². 63A in Sheet Steel enclosure = 25mm²

F400 Fire Rated Switchgear																			
Application	Sym.	Unit	Category	20A	25A	32A	40A	40AT	63A	80A	125A	160A	200A	250A	315A	400A	630A	1250A	
Rated thermal current	$I_{t_{he}}$	A		20	25	32	40	40	63	80	125	160	200	250	315	400	630	1250	
Rated insulation voltage	U_i	V		690	690	690	690	690	690	690	690	1000	1000	1000	1000	1000	1000	1000	
Rated impulse voltage	U_{imp}	kV		6	6	6	6	6	6	6	6	12	12	12	12	12	12	8	
Rated operational current (3 phase AC 50/60Hz)	I_e	A	400V / 415V AC23A	20	25	32	32	40	63	80	100	160	200	250	315	400	630	1250	
			690V AC23A	-	-	-	-	-	-	-	-	-	160	200	250	315	350	350	-
Rated operational power	P_e	kW	415V	9.5	11	15	15	18.5	30	40	55	90	110	132	175	200	315	500	
Conditional short circuit current	Fuse gG (A)	kA / Fuse (A)	415V	50 / 32	50 / 32	50 / 32	50 / 32	50 / 40	50 / 63	50 / 150	50 / 150	50 / 160	50 / 200	50 / 250	50 / 315	50 / 400	50 / 630	50 / 1250	
			690V	40 / 32	40 / 32	40 / 32	40 / 32	-	-	50 / 63	50 / 63	50 / 63	50 / 160	50 / 200	50 / 250	50 / 315	50 / 400	50 / 630	50 / 1250
Short circuit making capacity	I_{cm}	kA	Peak value	-	-	-	-	-	-	-	-	35	35	35	65	65	80	105	
Short circuit withstand	I_{cw}	kA	RMS value	-	-	-	-	-	-	1.5	1.5	8	8	8	17	17	17	50.0	
Recommended connecting capacity			Terminal type																
		mm ²	Flexible cable	6	6	6	6	10	10	50	50	95	95	120	2 / 150	2 / 150	2 / 185	4 / 300	
		mm ²	Rigid cable	10	10	10	10	16	16*	35	50	95	95	120	2 / 150	2 / 150	2 / 185	4 / 300	
		mm	Stud/Cu Palm Width	-	-	-	-	-	-	M10 / 21	M10 / 21	M10 / 30	M10 / 30	M10 / 30	M10 / 30	M10 / 40	M10 / 40	M10 / 60	
		Nm	Tightening torque	1.2	1.2	1.2	1.2	2	2	12	12	30	30	30	30	30	30	50	

DIMENSIONS

Size FA

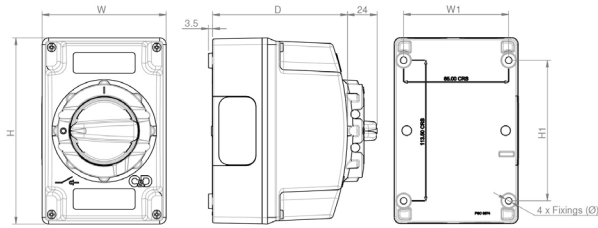
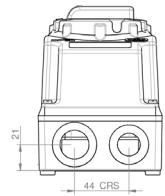

Size FB

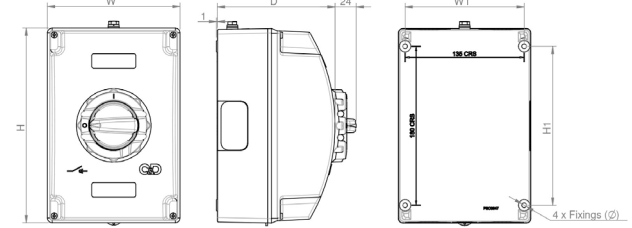
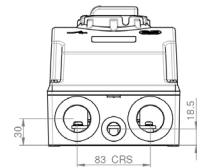

Sizes F1- F9

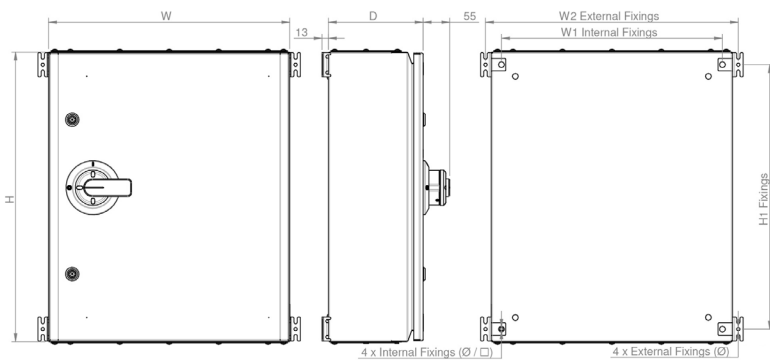

Encl. Size	Overall Dims.			Fixing Details			
	H	W	D	H1	W1	W2	Ø
FA	150.25	100.25	122.5	113.5	85	--	5.5
FB	220	150	134	180	135	--	5.5
F1	300	300	150	248	258	324	7
F2	400	300	200	348	258	324	7
F4	500	300	250	448	258	324	7
F5	600	500	200	548	458	524	7
F6	800	600	200	748	558	624	7
F7	800	600	300	748	558	624	7
F8	1000	600	300	948	558	624	7
F9	1400	800	300	1288	--	824	7

F400 FIRE RATED JUNCTION BOX



To complement our fire rated switchgear range, we have introduced a new F400 cable junction box. We offer two variants with 8-way or 12-way wire in / wire out terminals. The terminals are constructed from high temperature grade ceramic material and Stainless Steel cable terminals.

Each IP65 junction box enclosure is manufactured from Die-Cast Aluminium with a powder coated Traffic Red (RAL 3020) finish, cover fixings in A2 Stainless Steel and two M20 threaded cable entries. Each enclosure is supplied with internal wall mounting fixings as standard, which are positioned outside of the IP seal. External wall mounting fixing feet are available on request. Use Cat No. F400EF.

All units have been tested to withstand 400°C for 2 hours to meet the stringent thermal requirements of BS EN 12101-3.

Other variants are available on request.

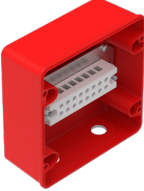

Junction Box									
Image	Rating	Format	Cat. No	Voltage	Encl. Size	Encl. Material	Encl. Colour	IP Rating	Max. Cable
	32A	8-Way	F400JBDR008	400V	A	Die-Cast Aluminium (LM6)	LU S1085 Compliant Paint Finish: Traffic Red (RAL 3020)	IP65	6mm
	32A	12-Way	F400JBDR012	400V	A	Die-Cast Aluminium (LM6)	LU S1085 Compliant Paint Finish: Traffic Red (RAL 3020)	IP65	6mm

DIMENSIONS

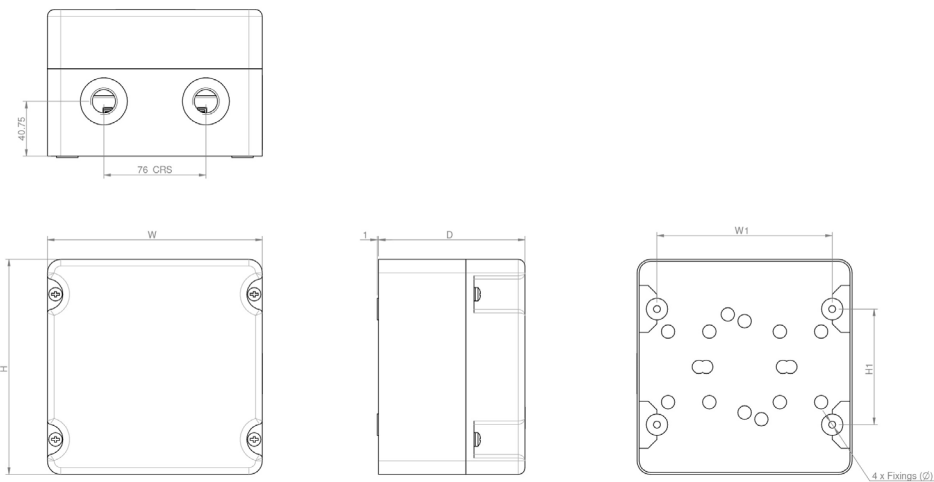

Encl. Size	Overall Dims.			Fixing Details			Cable Entries
	H	W	D	H1	W1	Ø	
A	160	160	110	86	130.5	5.5	2 x M20

TFL / LU SWITCHGEAR

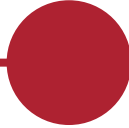

Following the London Kings Cross fire of 1987, the resulting Fennell enquiry prompted the introduction of additional fire precautions for 'Sub-surface Railway Stations'. These additional requirements were introduced under section 12 of the Fire Precautions Act 1971, and since then have been known simply as Section 12 regs. These regulations have been revoked and partly replaced with:- 'The Fire Precautions (Sub-surface Railway Stations) (England) Regulations 2009.

This range of enclosed switchgear have all been designed for the isolation and distribution of electrical supplies, for use on sub-surface and surface railway station installations. They have been designed in accordance with the requirements of TFL (LU) fire regulations and international low voltage switchgear standards.

Standards Applied: BS EN 60947-3, BS EN 12101-3, BS EN 60529, S1069, S1085, S1109, Directive 2006/42/EU, Directive 2014/35/EU, Directive 2014/30/EU.



TFL (LU) DIE-CAST ALUMINIUM & STAINLESS STEEL ENCLOSED SWITCHGEAR

This range of Switch Disconnectors are available in 25A & 40A ranging from 2P to 6P+2EB Aux. Supplied in either IP65 Die-Cast Aluminium enclosures finished in Light Grey (RAL 7035) LU S1085 compliant paint or IP65 Stainless Steel Grade 304 enclosures in a natural brushed finish.

Each unit is supplied with earthing points on both the lid and base, plus an external stud for earth bonding. The Die-Cast handle is padlockable in both 'Off' and 'On' positions. Optional security head fixing screws and external mounting brackets are available on request. Engraved traffolyte labels in various colours can be supplied attached to the side of the enclosure or supplied loose for fitting adjacent to the isolator. To order spare switch interiors, add suffix '/INT' to the part number e.g. DCG252/LUL2/INT

'NL' = unswitched neutral | 'EB' = 2 N/O early break auxiliary contacts

Switch Disconnectors (O-I)								
Image	Rating	Format	Cat. No.	Encl. Size	Encl. Material	Encl. Colour	IP Rating	Cable Entries
	25A	2P	DCG252/LUL2	FA	Die-Cast Aluminium	Light Grey (RAL 7035)	IP65	1xM20 + 1xM25 Top & Btm
		3P	DCG253/LUL2					
		3P+NL	DCG253NL/LUL2					
		3P+2EB Aux	DCG253EB/LUL2					
		4P	DCG254/LUL2					
		6P	DCG256/LUL2					
		6P+2EB Aux	DCG256EB/LUL2					1xM20 + 1xM25 Top & Btm 1xM20 RHS
	40A	2P	DCG402/LUL2	FB	Die-Cast Aluminium	Light Grey (RAL 7035)	IP65	2 x M25 Top & Btm
		3P	DCG403/LUL2					
		3P+NL	DCG403NL/LUL2					
		3P+2EB Aux	DCG403EB/LUL2					
		4P	DCG404/LUL2					
		6P	DCG406/LUL2					
		6P+2EB Aux	DCG406EB/LUL2					2 x M25 Top & Btm. 1 x M20 Btm
	25A	2P	DS252/LUL2	A	Stainless Steel Grade 304	Natural Brushed Finish	IP65	2 x M20
		3P	DS253/LUL2					
		3P+NL	DS253NL/LUL2					
		3P+2EB Aux	DS253EB/LUL2					
		4P	DS254/LUL2					
	40A	2P	DS402/LUL2	B	Stainless Steel Grade 304	Natural Brushed Finish	IP65	2 x M20 + 2 x M25
		3P	DS403/LUL2					
		3P+NL	DS403NL/LUL2					
		3P+2EB Aux	DS403EB/LUL2					
		4P	DS404/LUL2					

ACCESSORIES

Fixing Screws	
Description	Cat. No.
Set Of 4 Off Security Lid Fixing Screws For Stainless Steel Enclosures	SS/SEC
Security Screwdriver Bit For Stainless Steel Enclosures	SS/SEC/TOOL
Set Of 4 Off Security Lid Fixing Screws For Die-Cast Aluminium Enclosures	DC/SEC
Security Screwdriver Bit For Die-Cast Aluminium Enclosures	DC/SEC/TOOL
External Fixing Feet	
Description	Cat. No.
External Fixing Feet For 25A Stainless Steel	EFA
External Fixing Feet For 40A Stainless Steel	EFB
External Fixing Feet For 25A Die-Cast Aluminium	EFD25
External Fixing Feet For 40A Die-Cast Aluminium	EFD40



TFL (LU) SHEET STEEL ENCLOSED SWITCHGEAR

A range of Switch Disconnectors and fuse combination units, supplied in IP65 hinged door Sheet Steel enclosure, coated in a protective LU S1085 Compliant Paint Finish: Grey (RAL 7035) powder coat finish, the range comes standard in a three phase and switched neutral configuration and is generously sized to allow easy cable connection. Current ratings of 40A- 800A for Switch Disconnectors and 32A- 630A for fuse combination units are offered in this style.

Each enclosure has removable top and bottom gland plates and a metal anodised aluminium operating handle lockable in both ON and OFF positions. These are also interlocked with the switching device in the ON position preventing unsafe access. All operating handles accept 3 padlocks with a 6.3mm shackle, optional castell locking available on request. For Castell lock option, add suffix 'CL' to the Cat. No. E.g. DCG00403N/LUL2/CL

The switch-disconnector range is fire rated for F200, designed specifically for installations where the supply must be maintained for 120 minutes at 200°C

'N' = switched neutral (early make, late break)

Switch Disconnectors (O-I)								
Image	Rating	Format	Cat No.	Encl. Size	Encl. Material	Encl. Colour	IP Rating	Cable Entries
	40A	3P+N	DCG00403N/LUL2	1	Sheet Steel	Light Grey (RAL 7035)	IP65	Gland Plates
	63A	3P+N	DCG00633N/LUL2	1	Sheet Steel	Light Grey (RAL 7035)	IP65	Gland Plates
	80A	3P+N	DCG00803N/LUL2	3	Sheet Steel	Light Grey (RAL 7035)	IP65	Gland Plates
	100A	3P+N	DCG01003N/LUL2	3	Sheet Steel	Light Grey (RAL 7035)	IP65	Gland Plates
	125A	3P+N	DCG01253N/LUL2	4	Sheet Steel	Light Grey (RAL 7035)	IP65	Gland Plates
	160A	3P+N	DCG01603N/LUL2	4	Sheet Steel	Light Grey (RAL 7035)	IP65	Gland Plates
	200A	3P+N	DCG02003N/LUL2	5	Sheet Steel	Light Grey (RAL 7035)	IP65	Gland Plates
	250A	3P+N	DCG02503N/LUL2	7	Sheet Steel	Light Grey (RAL 7035)	IP65	Gland Plates
	315A	3P+N	DCG03153N/LUL2	8	Sheet Steel	Light Grey (RAL 7035)	IP65	Gland Plates
	400A	3P+N	DCG04003N/LUL2	8	Sheet Steel	Light Grey (RAL 7035)	IP65	Gland Plates
	630A	3P+N	DCG06303N/LUL2	10	Sheet Steel	Light Grey (RAL 7035)	IP65	Gland Plates
800A	3P+N	DCG08003N/LUL2	10	Sheet Steel	Light Grey (RAL 7035)	IP65	Gland Plates	
Fuse Combination Units (O-I)								
	32A	3P+N	SFDCG00323N/LUL2	2	Sheet Steel	Light Grey (RAL 7035)	IP65	Gland Plates
	63A	3P+N	SFDCG00633N/LUL2	2	Sheet Steel	Light Grey (RAL 7035)	IP65	Gland Plates
	100A	3P+N	SFDCG01003N/LUL2	4	Sheet Steel	Light Grey (RAL 7035)	IP65	Gland Plates
	160A	3P+N	SFDCG01603N/LUL2	4	Sheet Steel	Light Grey (RAL 7035)	IP65	Gland Plates
	200A	3P+N	SFDCG02003N/LUL2	6	Sheet Steel	Light Grey (RAL 7035)	IP65	Gland Plates
	250A	3P+N	SFDCG02503N/LUL2	6	Sheet Steel	Light Grey (RAL 7035)	IP65	Gland Plates
	315A	3P+N	SFDCG03153N/LUL2	9	Sheet Steel	Light Grey (RAL 7035)	IP65	Gland Plates
	400A	3P+N	SFDCG04003N/LUL2	9	Sheet Steel	Light Grey (RAL 7035)	IP65	Gland Plates
	630A	3P+N	SFDCG06303N/LUL2	11	Sheet Steel	Light Grey (RAL 7035)	IP65	Gland Plates

ACCESSORIES

Add-on auxiliary blocks are available for all hinged door products. All auxiliaries are supplied as 1 N/O+1 N/C pair. All N/O auxiliary contacts are early break with respect to the main poles when switching from 'On' to 'Off'

Auxiliary Contacts	
Description	Cat. No.
Auxiliary Contact For 32A- 160A Fuse Combination Units	SAUXKITA
Auxiliary Contact For 40A- 200A Switch Disconnectors	SAUXCO
Auxiliary Contact For 200A- 400A Fuse Combination Units & 400A- 800A Switch Disconnectors	SAUXKITC
Auxiliary Contact For 250A Switch Disconnectors	SAUXKITB
Auxiliary Contact For 630A Fuse Combination Units	SAUXKITD

TFL (LU) F400 FIRE RATED ENCLOSED SWITCHGEAR





The 20A to 630A F400 Fire Rated product range is supplied in either an IP65 Die-Cast Aluminium enclosure or a hinged door Sheet Steel enclosure, coated in a protective LU S1085 Compliant Paint Finish: Red (RAL3020) powder coat finish. The Die-Cast Aluminium products, 20A-40A, are fitted with a black powder coated Die-Cast Aluminium handle while the Sheet Steel enclosed products, 63A and above, are fitted with a highly durable aluminium operating handle. All units from this range feature the ability to be padlocked in both the OFF and ON positions as standard.

The interior switches are constructed from a high temperature grade thermoset material, designed specifically for installations where the supply must be maintained for 2 hours at 400°C. All units are suitable for enhanced fire rated cables. When using enhanced fire resistant power cables, please check gland sizes to suit the required product. All F400 products are suitable for F300 applications.

Stainless Steel 316L enclosures are available on request for the hinged door Sheet Steel product range. Replace 'R' with 'S' in the catalogue number, e.g. F400SDS0633NL/LUL2.

Factory fitted auxiliaries on the 20A-125A are fully rated and fire rated to F400. Non-fire rated auxiliaries are available for the 160A-630A hinged door Sheet Steel products on request, add '/AUX' to the catalogue number, e.g. F400SDR01604/LUL2/AUX

'NL' = unswitched neutral | 'EB' = 2 N/O early break auxiliary contacts

Switch Disconnectors (O-I)									
Image	Rating	Format	Cat. No.	Encl. Size	Encl. Material	Encl. Colour	IP Rating	Cable Entries	
	20A	2P	F400DDR00202/LUL2	FA	Die-Cast Aluminium	Red (RAL 3020)	IP65	1xM20+1xM25 Top & Btm	
		3P	F400DDR00203/LUL2						
		3P+NL	F400DDR00203NL/LUL2						
		3P+2EB Aux	F400DDR00203EB/LUL2						
		4P	F400DDR00204/LUL2						
		6P	F400DDR00206/LUL2						
		6P+2EB Aux	F400DDR00206EB/LUL2					1xM20+1xM25 Top & Btm+1xM20 Rhs	
	25A	2P	F400DDR00252/LUL2	FA	Die-Cast Aluminium	Red (RAL 3020)	IP65	1xM20+1xM25 Top & Btm	
		3P	F400DDR00253/LUL2						
		3P+NL	F400DDR00253NL/LUL2						
		3P+2EB Aux	F400DDR00253EB/LUL2						
		4P	F400DDR00254/LUL2						
		6P	F400DDR00256/LUL2						
		6P+2EB Aux	F400DDR00256EB/LUL2					1xM20+1xM25 Top & Btm+1xM20 Rhs	
	40A	2P	F400DDR0040T2/LUL2	FB	Die-Cast Aluminium	Red (RAL 3020)	IP65	2xM25 Top & Btm	
		3P	F400DDR0040T3/LUL2						
		3P+NL	F400DDR0040T3NL/LUL2						
		3P+2EB Aux	F400DDR0040T3EB/LUL2						
		4P	F400DDR0040T4/LUL2						
		6P	F400DDR0040T6/LUL2						
		6P+2EB Aux	F400DDR0040T6EB/LUL2					2xM25 Top & Btm + 1xM20 Btm	
	63A	3P+NL	F400SDR00633NL/LUL2	F1	Sheet Steel	Red (RAL 3020)	IP65	Gland Plates	
		3P+2EB Aux	F400SDR00633EB/LUL2						
	80A	3P+2EB Aux	F400SDR00803EB/LUL2	F2	Sheet Steel	Red (RAL 3020)	IP65	Gland Plates	
		4P	F400SDR00804/LUL2						
	125A	3P	F400SDR01253/LUL2	F4	Sheet Steel	Red (RAL 3020)	IP65	Gland Plates	
		3P+2EB Aux	F400SDR01253EB/LUL2						
			4P	F400SDR01254/LUL2					
	160A	4P	F400SDR01604/LUL2	F5	Sheet Steel	Red (RAL 3020)	IP65	Gland Plates	
	200A	4P	F400SDR02004/LUL2	F5	Sheet Steel	Red (RAL 3020)	IP65	Gland Plates	
	250A	4P	F400SDR02504/LUL2	F5	Sheet Steel	Red (RAL 3020)	IP65	Gland Plates	
	315A	4P	F400SDR03154/LUL2	F6	Sheet Steel	Red (RAL 3020)	IP65	Gland Plates	
	400A	4P	F400SDR04004/LUL2	F6	Sheet Steel	Red (RAL 3020)	IP65	Gland Plates	
	630A	4P	F400SDR06304/LUL2	F8	Sheet Steel	Red (RAL 3020)	IP65	Gland Plates	

TFL (LU) FORM 4 TYPE 2 AUTOMATIC TRANSFER SWITCHES (ATS) - SOLENOID TYPE, CLASS PC

At the core of each system is a four-pole ABB TruONE transfer switch. Rated 230V or 400V AC the ATS will provide all the essential requirements for automatically switching to a replacement power source. Units are rated from 32A to 250A with a rated frequency of 50/60Hz.

The Single or Three-phase ATS units allow automatic connection of a secondary electrical supply to a load upon failure of the primary supply.



The Bypass function isolates the ATS by bypassing the 'S1' supply or (in the case of dual-line versions) the 'S2' supply directly to the outgoing load, enabling essential maintenance. The 'S1' supply may be bypassed without a break in supply in accordance with life safety recommendations. The key advantage is that both the 'S1' supply and 'S2' supply to the load can be maintained whilst service and repairs can be carried out on the ATS unit.

Supplied in Sheet Steel enclosures up to IP65 with a Light Grey (RAL 7035) paint finish, each enclosure comes standard with a removable gland plate(s). Stainless Steel options are available on request.

Each ATS unit comes standard with incoming isolators for both primary and secondary supplies. Volt-free status relays are included alongside a modbus communication module within the ATS unit in order to connect to the BMS (building management system) and/or life safety systems installed within the building.





The main LED indicator lights show the status of the supplies. A test switch is supplied with a set of 2 keys to allow for testing and commissioning of the ABB TruONE transfer switch. A mains return inhibit feature is accessible through the TruONE HMI. Incoming isolators and the bypass arrangement are separated from each other and from the transfer switch using rigid metallic barriers resulting in Form 4, type 2 separation.

Applied standards: BS EN 60947-1, BS EN 60947-3, BS EN 60947-5-1, BS EN 60947-6-1, BS EN 61439-1, BS 8519, S1069, S1085, S1089, S1109, S1909

TFL/LU Single Line Maintenance Bypass ATS with Incoming Switches								
Image	AC33 Rating	Cat. No.		Encl. Size	Encl. Material	Encl. Colour	IP Rating	Max Cable Size
		Single Phase	Three Phase					
	32A	ATS0322A234	ATS0324A234	1200x800x300	Sheet Steel	Light Grey (RAL 7035)	IP65	16mm ² Btm
	45A	ATS0452A234	ATS0454A234	1200x800x300	Sheet Steel	Light Grey (RAL 7035)	IP65	16mm ² Btm
	63A	-	ATS0634A234	1200x800x300	Sheet Steel	Light Grey (RAL 7035)	IP65	50mm ² Btm
	100A	-	ATS1004A234	1200x800x300	Sheet Steel	Light Grey (RAL 7035)	IP65	70mm ² Btm
	160A	-	ATS1604A434	1800x1000x400	Sheet Steel	Light Grey (RAL 7035)	IP55	70mm ² Top
	250A	-	ATS2504A434	1800x1000x400	Sheet Steel	Light Grey (RAL 7035)	IP55	150mm ² Top
TFL/LU Dual Line Maintenance Bypass ATS with Incoming Switches								
	32A	ATS0322A244	ATS0324A244	1200x800x300	Sheet Steel	Light Grey (RAL 7035)	IP65	16mm ² Btm
	45A	ATS0452A244	ATS0454A244	1200x800x300	Sheet Steel	Light Grey (RAL 7035)	IP65	16mm ² Btm
	63A	-	ATS0634A244	1200x800x300	Sheet Steel	Light Grey (RAL 7035)	IP65	50mm ² Btm
	100A	-	ATS1004A244	1200x800x300	Sheet Steel	Light Grey (RAL 7035)	IP65	70mm ² Btm
	160A	-	ATS1604A444	1800x1000x400	Sheet Steel	Light Grey (RAL 7035)	IP55	70mm ² Top
	250A	-	ATS2504A444	1800x1000x400	Sheet Steel	Light Grey (RAL 7035)	IP55	150mm ² Top

TECHNICAL SPECIFICATION - DIE-CAST ALUMINIUM & STAINLESS STEEL

Data supplied against tests to IEC/BS EN 60947-3.

Die-Cast Aluminium Switchgear					
Application	Sym.	Unit	Category	25A	40Av
Rated thermal current	I_{the}	A		25	40
Rated Insulation voltage	U_i	V		690	690
Rated Impulse voltage	U_{imp}	kV		6	6
Rated operational current (3 phase AC 50/60Hz)	I_e	A	415V AC23A	25	40
Rated operational power	P_e	kW	415V	11	18.5
Conditional short circuit current	Fuse gG	kA / Fuse (A)	415V	50 / 32	50 / 40
Recommended connecting capacity			Terminal type		
		mm ²	Flexible cable	6	10
		mm ²	Rigid cable	10	16
		mm	Stud/Cu Palm Width	-	-
		Nm	Tightening torque	1.2	2
Stainless Steel Switchgear					
Application	Sym.	Unit	Category	25A	40A
Rated thermal current	I_{the}	A		25	40
Rated insulation voltage	U_i	V		690	690
Rated impulse voltage	U_{imp}	kV		6	6
Rated operational current (3 phase AC 50/60Hz)	I_e	A	400V AC23A	21	35
Rated operational power	P_e	kW	230V	3.7	6
			400V	11	18.5
Rated short time withstand current	I_{cw}	A	1 sec	500	1100
			10kA	35	80
			25kA	32	63
Max. fuse size for short circuit protection	gG	kA	50kA	32	63
Recommended connecting capacity		-	Terminal type		
		mm ²	Flexible cable	6	16
		mm ²	Rigid cable	10	25
		Nm	Tightening torque	1.2	1.2

TFL/LU DIE-CAST ALUMINIUM

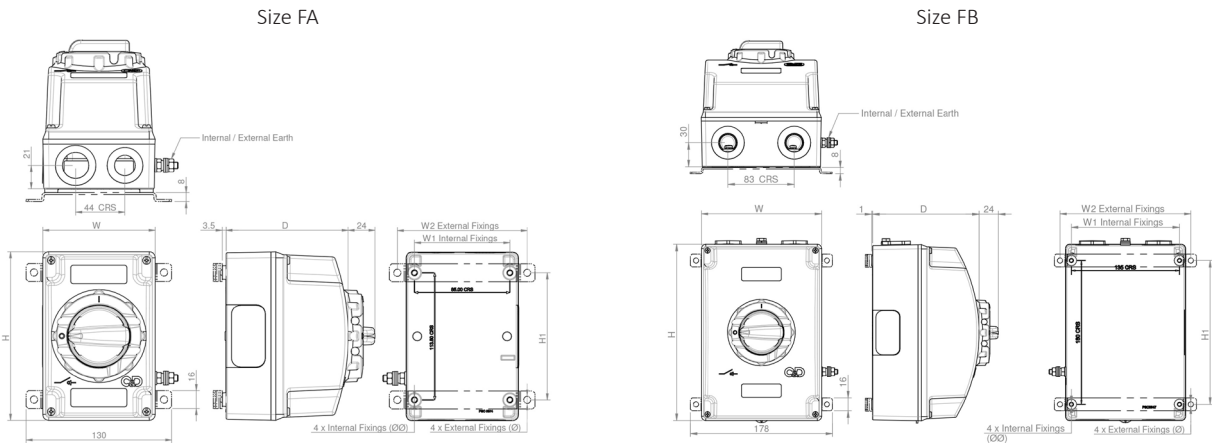

TFL/LU STAINLESS STEEL

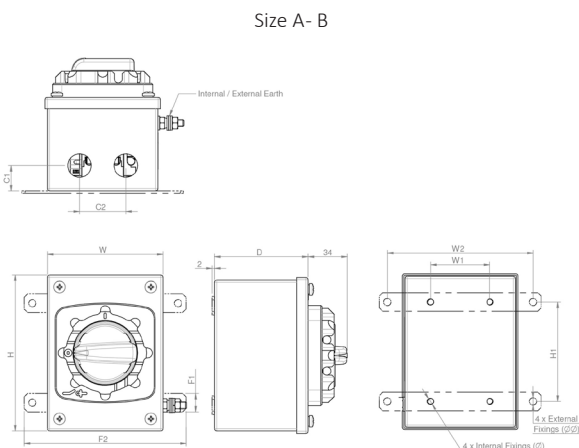

Encl. Size	Overall Dims.			Fixing Details				
	H	W	D	H1	W1	W2	Ø	Ø Ø
FA	150	100	109	113.5	85	116	6.5	4
FB	220	150	133.5	180	135	164	6.5	4
A	135	100	81	86	52	126	6.5	5.5
B	175	130	99	126	81	155	6.5	5.5

TECHNICAL SPECIFICATION - SHEET STEEL

Data supplied against tests to IEC/BS EN 60947-3.

Sheet Steel Switch Disconnectors															
Application	Sym	Unit	Category/v	40	63	80	100	125	160	200	250	315	400	630	800
Rated thermal current	I_{the}	A		40	63	80	100	125	160	200	250	315	400	630	720
Rated insulation voltage	U_i	V		690	690	1000	1000	1000	1000	1000	1000	1000	1000	1000	1000
Rated impulse voltage	U_{imp}	kV		6	6	8	8	8	8	8	12	12	12	12	12
Rated operational current	I_e	A	400V AC23A	35	47.5	80	100	112	128	128	250	315	400	630	720
Rated operational power	P_e	kW	400 / 415V AC23A	18.5	25	59	59	63	75	75	132	160	200	315	355
Short circuit making capacity	I_{cm}	kA	Peak value	2.7	2.9	3.0	3.7	4.0	5.0	5.0	35	35	65	80	80
Short circuit withstand (1sec)	I_{cw}	kA	rms value	1.1	1.3	2	2.6	2.8	3.0	3.0	8	8	17	17	17
Min. mechanical endurance	-	-	Operations (10^3)	250	250	50	50	50	50	50	16	16	10	10	10
Min. electrical endurance	-	-	415V at 0.65 pf	-	-	-	-	-	-	-	1,000	1,000	1,000	500	500
Connecting capacity	-	-	Terminal type												
	mm ²		Min/Max	2.5/25	2.5/25	-/50	-/50	-/70	-/95	-/95	120	2x150	2x150	2x185	2x240
	mm		Stud/Cu palm width	-	-	-	-	-	8x25	8x25	10x30	10x30	10x30	12x40	12x40
	Nm		Tightening torque	1.3	1.3	5	5	5	12	12	25	25	25	40	40

Sheet Steel Fuse Combination Units (O-I)															
Application	Sym	Unit	Category	32	63	100	125	160	200	250	315	400	630	800	
Rated thermal current	I_{the}	A		32	63	100	125	160	200	250	315	400	630	800	
Rated insulation voltage	U_i	V		750	750	750	750	750	1000	1000	1000	1000	1000	1000	
Rated impulse voltage	U_{imp}	kV		12	12	12	12	12	12	12	12	12	12	12	
Rated operational current	AC	I_e	A	415V AC23A	32	63	100	125	160	200	250	315	400	630	720
	DC		A	220V DC23A	-	-	100/4	100/4	100/4	200/3	250/3	315/3	400/3	630/3	800/3
Rated making capacity (AC23A)		A	415V, 0.35 pf	320	630	1,000	1,250	1,600	2,000	2,500	3,150	4,000	6,300	8,000	
Rated breaking capacity (AC23A)		A	415V, 0.35 pf	256	504	800	1,000	1,280	1,600	2,000	2,520	3,200	5,040	5,760	
Rated conditional (fused) short circuit	kA	kA	S/C current rms	80	80	80	80	80	80	80	80	80	80	80	
	A	A	back-up fuse gG	32	63	100	125	160	200	250	315	400	630	800	
Min. mechanical endurance		-	Operations	25000	25000	15000	15000	15000	10000	10000	10000	10000	10000	10000	
Min. electrical endurance		-	415V at 0.65 pf	1,500	1,500	1,000	1,000	1,000	1,000	1,000	1,000	1,000	1,000	1,000	
BS fuse format				A3	A3	A4	A4	B1, B2	B1, B2	B1, B2	B1, B4	B1, B4	C1, C3	C1, C3	
Connecting capacity	-	-	Terminal type												
	mm ²		Min/Max	16	25	95	95	120	150	185	240	300	400	400	
	mm		Stud/Cu palm width	-	-	8x20	8x20	8x20	10x25	10x25	10x25	10x25	12x50	12x50	
	Nm		Tightening torque	2.5	2.5	10	10	10	30	30	30	30	50	50	

DIMENSIONS

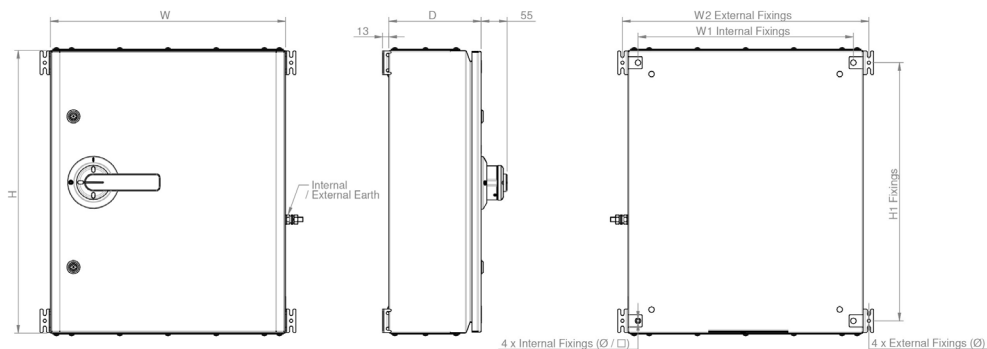

Encl. Size	H	W	D	H1	W1	W2	Ø	Ø Ø
1	300	300	150	248	258	324	10.5	7
2	400	400	200	348	358	424	10.5	7
3	400	300	150	348	258	324	10.5	7
4	500	400	200	448	358	424	10.5	7
5	600	400	200	548	358	424	10.5	7
6	600	600	300	548	558	624	10.5	7
7	600	500	200	548	458	524	10.5	7
8	800	600	200	748	558	624	10.5	7
9	800	600	300	748	558	624	10.5	7
10	1000	600	300	948	558	624	10.5	7
11	1000	800	300	948	758	824	10.5	7

TECHNICAL SPECIFICATION - FIRE RATED

Data supplied against tests to IEC/BS EN 60947-3.

Fire Rated Switchgear																
Application	Sym.	Unit	Category	20A	25A	40A	63A	80A	125A	160A	200A	250A	315A	400A	630A	
Rated thermal current	I_{th}	A		20	25	40	63	80	125	160	200	250	315	400	630	
Rated Insulation voltage	U_i	V		690	690	690	690	690	690	1000	1000	1000	1000	1000	1000	
Rated Impulse voltage	U_{imp}	kV		6	6	6	6	6	6	12	12	12	12	12	12	
Rated operational current	I_e	A	415V AC23A	20	25	40	63	80	100	160	200	250	315	400	630	
			690V AC23A	-	-	-	-	-	-	160	200	250	315	350	350	
Rated operational power	P_e	kW	415V	9.5	11	18.5	30	40	55	90	110	132	200	200	315	
Conditional short circuit current	Fuse gG	kA/Fuse (A)	415V	50/32	50/32	50/40	50/63	50/150	50/200	50/160	50/200	50/250	50/315	50/400	50/630	
			690V	40/32	40/32	-	-	50/63	50/63	50/160	50/200	50/250	50/315	50/400	50/630	
Short circuit making capacity	I_{cm}	kA	Peak value	-	-	-	-	-	-	35	35	35	65	65	80	
Short circuit withstand	I_{cw}	kA	RMS value	-	-	-	-	1.5	1.5	8	8	8	17	17	17	
Recommended connecting capacity			Terminal type													
	mm ²	Flexible cable		6	6	10	10	50	50	95	95	120	2/150	2/150	2/185	
	mm ²	Rigid cable		10	10	16	25	35	50	95	95	120	2/150	2/150	2/185	
	mm	Stud/Cu Palm Width		-	-	-	-	M10/21	M10/21	M10/30	M10/30	M10/30	M10/30	M10/30	M10/40	M10/40
	Nm	Tightening torque		1.2	1.2	2	2	12	12	30	30	30	30	30	30	30

DIMENSIONS

Size FA

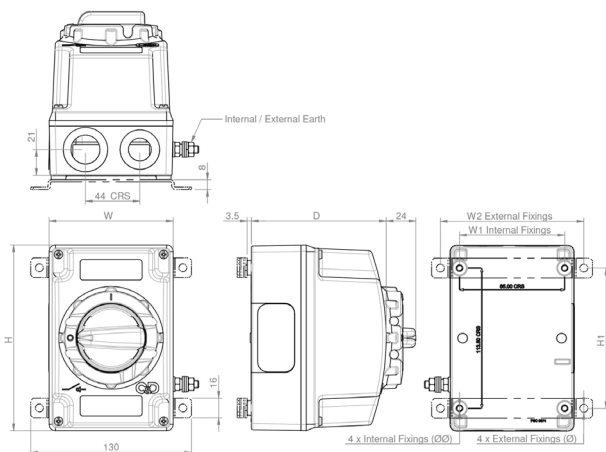

Size FB

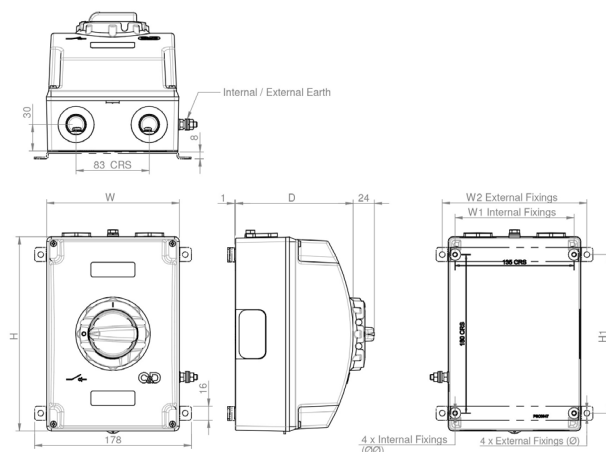

Sizes F1- F8

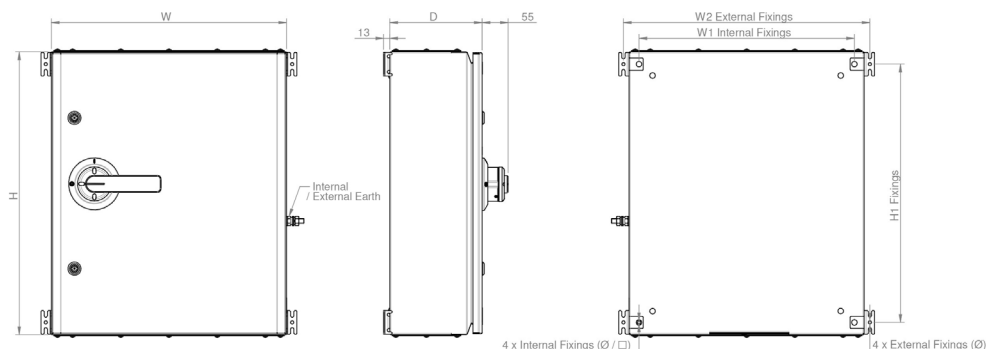

Encl. Size	H	W	D	H1	W1	W2	Ø	Ø Ø
FA	150	100	109	113.5	85	116	6.5	4
FB	220	150	133.5	180	135	164	6.5	4
F1	300	300	150	248	258	324	10.5	7
F2	400	300	200	348	258	324	10.5	7
F4	500	300	250	448	258	324	10.5	7
F5	600	500	200	548	458	524	10.5	7
F6	800	600	200	748	558	624	10.5	7
F8	1000	600	300	948	558	624	10.5	7

EXPLOSION PROOF



Craig & Derricott has been associated with the design and manufacture of Ex products for more than 40 years. The current product range has been developed to meet the technical requirements of today's market and a great deal of the design consideration has been given to bringing a quality product to the market at a competitive price.



EXPLOSION PROOF - ZONE 1, 2, 21 AND 22 EX DB EB TB

The EXZ1 range of enclosed Switch Disconnectors are supplied in glass reinforced polyester enclosures with sealing to IP65 ensuring the product will withstand being installed in the harshest of industrial environments.

The operating handles come standard in Red/Yellow and can be padlocked in the 'Off' position. All lids are mechanically interlocked with the isolating switch and are removable in the 'On' position only. If you would require a black handle instead please replace R in the Cat. No. with a B e.g. EXZ1SDR02530.

Available in ratings from 25A- 180A the isolating switch interiors are supplied in either 3 or 4 pole formats complete with 1 N/O (Early break) & 1 N/C (Late make) auxiliary contacts.

Optional Brass Earthing Plates are available on request to enable armoured cables to be earth bonded within the insulated enclosure a selection of pre-drilled earthing plates are available for each enclosure size.

Certification

All items have been approved with ATEX (CML 15ATEX1197X), IECEx (IECEx CML 15.0093X) and UKEX (CML 21UKEX1353X) certificates for use in Zones 1, 2, 21 & 22.

The equipment is designed and tested to comply with the following:-

- EN 60079-0 Electrical Atmospheres, Part 0 : Equipment- general requirements.
- EN 60079-1 Electrical Atmospheres, Part 1 : Equipment protection by flameproof enclosures 'd'.
- EN 60079-7 Electrical Atmospheres, Part 7 : Equipment protection by increased safety 'e'.
- EN 60947-1 Low-Voltage switchgear and controlgear- Part 1: general rules.
- EN 60947-3 Low-Voltage switchgear and controlgear- Part 3: switches, disconnectors, switch disconnectors and fuse combination units.
- EN 60529 Degrees of protection provided by enclosures. (IP Code)

Key to Marking

- ☑ Specific marking for Explosion protection
- II Equipment group
- 2 Equipment category
- G Environment e.g. Gas



Switch Disconnectors (O-I)									
Image	Rating	Format	Cat. No.	Encl. Size	Encl. Material	IP Rating	Opt. Brass Earthing Plate Cat. No.	Equipment Marking	Min & Max Temp.
	25A	3P+Aux	EXZ1SDR02530	A	Glass Reinforced Polyester	IP65	EXEP0254	25A ☑ II 2 GD Ex db eb IIC T6 Gb Ex tb IIIC T80°C Db	-40°C to +40°C
		4P+Aux	EXZ1SDR02540					25A ☑ II 2 GD Ex db eb IIC T5 Gb Ex tb IIIC T95°C Db	-40°C to +55°C
	40A	3P+Aux	EXZ1SDR04030	B	Glass Reinforced Polyester	IP65	EXEP0404	40A ☑ II 2 GD Ex db eb IIC T6 Gb Ex tb IIIC T80°C Db	-40°C to +40°C
		4P+Aux	EXZ1SDR04040					40A ☑ II 2 GD Ex db eb IIC T5 Gb Ex tb IIIC T95°C Db	-40°C to +55°C
	80A	3P+Aux	EXZ1SDR08030	C	Glass Reinforced Polyester	IP65	EXEP0804	80A ☑ II 2 GD Ex db eb IIC T6 Gb Ex tb IIIC T80°C Db	-40°C to +40°C
		4P+Aux	EXZ1SDR08040					80A ☑ II 2 GD Ex db eb IIC T5 Gb Ex tb IIIC T95°C Db	-40°C to +55°C
	180A	3P+Aux	EXZ1SDR18030	D	Glass Reinforced Polyester	IP65	EXEP1804	180A ☑ II 2 GD Ex db eb IIC T5 Gb Ex tb IIIC T95°C Db	-40°C to +40°C
		4P+Aux	EXZ1SDR18040					180A ☑ II 2 GD Ex db eb IIC T4 Gb Ex tb IIIC T130°C Db	-40°C to +55°C

EXPLOSION PROOF - ZONE 22

Using high quality Die-Cast Aluminium and hinged door Sheet Steel enclosures the range covers 20A- 630A ratings. All items allow for the fitting of up to three padlocks in the 'Off' position. Units are inclusive of fixings outside of the enclosure seal area and an external earth point.

People normally think of such atmospheres as being gases, mists or vapours, however there are various industries where a conductive or non-conductive dust mixed with air in the right proportion can become explosive. It is these areas where the Craig & Derricott ATEX Group II (Zone 22) equipment can be used to help you comply with Health & Safety regulations.





Certification and Approvals







- Certification Code  II 3D
 tc III B T85°C Dc
- Certification standard BS EN 60079-0, BS EN 60079-31, BS EN 60529, BS EN 60947-3, BS EN 60204-1











Switch Disconnectors (O-I)								
Image	Rating	Format	Cat. No.	Encl. Size	Encl. Material	Encl. Colour	IP Rating	Cable Entries
	20A	6P+2EB Aux	SDDG206EBZ22	A22	Die-Cast Aluminium	Light Grey RAL 7035	IP65	1 x M20 Top + 2 x M20 Bottom
	25A	3P+2EB Aux	SDDG253EBZ22	A22	Die-Cast Aluminium	Light Grey RAL 7035	IP65	1 x M20 Top + 2 x M20 Bottom
	32A	3P+2EB Aux	SDDG323EBZ22	A22	Die-Cast Aluminium	Light Grey RAL 7035	IP65	1 x M20 Top + 2 x M20 Bottom
		6P+2EB Aux	SDDG326EBZ22	B22				2 x M25 + 1 x M20 Bottom
	40A	3P+2EB Aux	SDDG403EBZ22	B22	Die-Cast Aluminium	Light Grey RAL 7035	IP65	2 x M25 + 1 x M20 Bottom
		6P+2EB Aux	SDDG406EBZ22					
63A	3P+2EB Aux	SDDG633EBZ22	B22	Die-Cast Aluminium	Light Grey RAL 7035	IP65	2 x M25 + 1 x M20 Bottom	
	32A	3P+N	EDG00323NZ22	1	Sheet Steel	Light Grey RAL 7035	IP65	Gland Plates
		3P+NL	EDG00323NLZ22					
	63A	3P+N	EDG00633NZ22	1	Sheet Steel	Light Grey RAL 7035	IP65	Gland Plates
		3P+NL	EDG00633NLZ22					
		3P+2EB Aux	EDG00633EBZ22					
		6P	EDG00636Z22					
	80A	6P+2EB Aux	EDG00636EBZ22	1	Sheet Steel	Light Grey RAL 7035	IP65	Gland Plates
		3P+N	EDG00803NZ22					
		3P+NL	EDG00803NLZ22					
	100A	6P	EDG00806Z22	1	Sheet Steel	Light Grey RAL 7035	IP65	Gland Plates
3P+N		EDG01003NZ22						
3P+NL		EDG01003NLZ22						
	125A	6P	EDG01006Z22	3	Sheet Steel	Light Grey RAL 7035	IP65	Gland Plates
		3P+N	EDG01253NZ22					
		3P+NL	EDG01253NLZ22					
	160A	6P	EDG01256Z22	3	Sheet Steel	Light Grey RAL 7035	IP65	Gland Plates
		3P+N	EDG01603NZ22					
		3P+NL	EDG01603NLZ22					
	200A	6P	EDG01606Z22	3	Sheet Steel	Light Grey RAL 7035	IP65	Gland Plates
		3P+N	EDG02003NZ22					
	250A	3P+NL	EDG02003NLZ22	4	Sheet Steel	Light Grey RAL 7035	IP65	Gland Plates
		3P+N	EDG02503NZ22					
400A	3P+NL	EDG02503NLZ22	5	Sheet Steel	Light Grey RAL 7035	IP65	Gland Plates	
	3P+N	EDG04003NZ22						
	3P+NL	EDG04003NLZ22						
	3P+N	EDG06303NZ22						
630A	3P+NL	EDG06303NLZ22	7	Sheet Steel	Light Grey RAL 7035	IP65	Gland Plates	
	3P+N	EDG06303NLZ22						

TECHNICAL SPECIFICATION

Data supplied against tests to IEC/BS EN 60947-3. * All AC21, AC22 & AC23 tests carried out at 415V.

Zone 1, 2, 21 and 22 EX db eb												
Application	Sym.	Unit	Category	Main Contacts				Aux. Contacts				
				25A	40A	80A	180A	Category	Aux.			
Rated thermal current	I_{the}	A		25	40	80	180		10			
Rated insulation voltage	U_i	V		690	690	690	690		690			
Rated current	-	A	AC3 (230V)	25	40	80	180	AC15 (250V)	10			
			AC3 (400V)	25	40	80	180	AC15 (400V)	8			
			AC3 (500V)	20	40	80	150	DC13 (24V)	8			
			AC3 (690V)	16	32	63	125	DC13 (250V)	1			
Terminal capacity		mm ²	-	2x4	2x10	2x25	2x95		2x1.5			
Tightening torque (Nm)			-	2.5	2.5	3.5	8.5		2.5			
Terminal type	-											

Zone 22 Die-Cast Aluminium										
Application	Sym.	Unit	Category	20A	25A	32A	40A	40A	63A	
Format	-	-	-	6P+2EB	3P+2EB	3P+6P	3P	6P	3P+6P	
Rated thermal current	I_{the}	A	-	20	25	32	40	40	63	
Rated insulation voltage	U_i	V	-	390	690	690	690	690	690	
Rated impulse voltage	U_{imp}	kV	-	6	6	6.0	6.0	6.0	6.0	
Rated operational current	I_e	A	400V AC23A (3 phase AC 50/60Hz)	15	25	32	40	40	54	
Rated operational power (3 phase AC)	I_e	kW	230V	2.2	3.7	4.8	6.0	6.0	9.4	
	P_e		400V	7.5	11	15	18.5	18.5	25	
Rated short time withstand current (1 sec)	I_{cw}	A	-	250	500	600	600	600	1300	
Max. fuse size for short circuit protection (gG Characteristic)	-	kA	10kA	20	35	35	40	40	80	
			25kA	16	32	32	32	32	63	
			50kA	-	32	32	32	32	63	
Connecting capacity	-	-	Terminal type							
	-	mm ²	Flexible cable	2.5 x 2	6	6	6	6	16	
	-	mm ²	Rigid cable	2.5 x 2	10	10	10	10	25	
	-	Nm	Tightening torque	1.0	1.2	1.2	1.2	1.2	1.2	

Zone 22 Sheet Steel															
Application	Sym.	Unit	Category	32	63		80	100	125	160	200	250	400	630	
				3P	3P	6P	3P	3P	3P	3P	3P	3P	3P	3P	
Format	-	-	-	3P	3P	6P	3P	3P	3P	3P	3P	3P	3P	3P	
Rated thermal current	I_{the}	A		32	63	63	80	100	125	160	200	250	400	630	
Rated insulation voltage	U_i	V		690	690	690	690	1000	1000	1000	1000	1000	1000	1000	
Rated impulse voltage	U_{imp}	kV		6	6	6	6	8	8	8	8	12	12	12	
Rated operational AC current	I_e	A	400V- AC21A	32	63	63	80	100	125	160	200	250*	400*	630*	
			690V- AC21A	32	63	63	80	100	125	160	200	250	400	630	
			400V- AC22A	-	-	-	-	100	125	160	200	250*	400*	630*	
			690V- AC22A	-	-	-	-	100	125	160	160	250	400	630	
			400V- AC23A	29	48	48	56	105	111	132	132	250*	400*	630*	
			690V- AC23A	17	33	33	33	-	-	-	-	250	350	350	
Rated operational DC current	I_e	A	Up to 48V- DC21A	32/1	63/1	63/1	80/1	-	-	-	-	250/2	400/2	630/1	
			220V- DC21A	-	-	-	-	-	-	-	-	250/2	400/2	630/2	
			Up to 48V- DC22A	-	-	-	-	-	-	-	-	250/2	400/1	630/1	
			220V- DC22A	-	-	-	-	-	-	-	-	250/2	400/2	630/2	
			Up to 48V- DC23A	-	-	-	-	-	-	-	-	250/2	400/1	630/1	
			220V- DC23A	-	-	-	-	-	-	-	-	250/2	400/2	630/2	
Rated operational power	P_e	kW	400/415V- AC23A	15	25	25	30	59	63	75	75	132	200	315	
			690V- AC23A	15	30	30	30	51	55	55	55	200	315	355	
Short circuit making capacity	I_{cm}	kA	Peak value	1.4	2.9	2.9	3	3.7	4	5	5	35	65	80	
Short circuit withstand (1sec)	I_{cw}	kA	rms value	0.6	1.3	1.3	1.4	2.6	2.8	3	3	8	17	17	
Min. mechanical endurance		-	Operations (103)	250	250	500	250	50	50	50	50	16	10	10	
Min. electrical endurance		-	415V- at 0.65 pf	-	-	-	-	-	-	-	-	1,000	1,000	500	
Connecting capacity	-	-	Terminal type												
		mm ²	Min/Max	2.5/10	2.5/25	2.5/25	2.5/25	-/35	-/70	-/70	-/95	120	2 x 150	2 x 185	
		mm	Stud/Cu palm width	-	-	-	-	-	-	-	-	8 x 25	10 x 30	10 x 30	12 x 40
		Nm	Tightening torque	1.2	1.2	1.2	1.2	5	5	5	10	30	30	50	

EXPLOSION PROOF EX DB EB

Size A-B

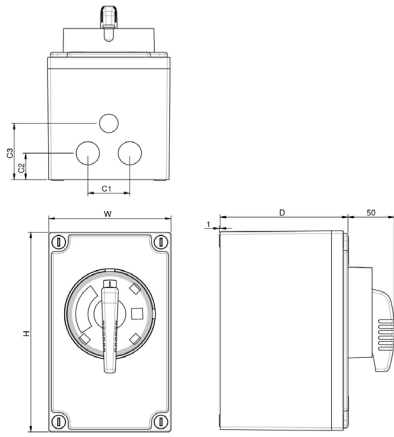

Size C-D

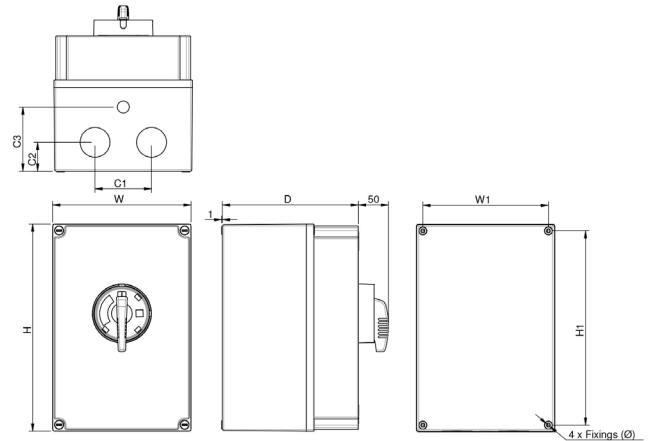

Encl. Size	Overall Dims.			Fixing Details			Cable Entries			
	H	W	D	H1	W1	Ø	C1	C2	C3	Entries
A	220	134	141	186	112	7	46	30	63	M20 + 2xM25
B	275	160	161	253	138	7	65.5	33	63	M20 + 2xM40
C	352	234	231	330	212	7	95.5	50	110	M20 + 2xM50
D	706	352	231	684	330	7	170	72	72	M20 + 2xM63

EXPLOSION PROOF ZONE 22

Size A22

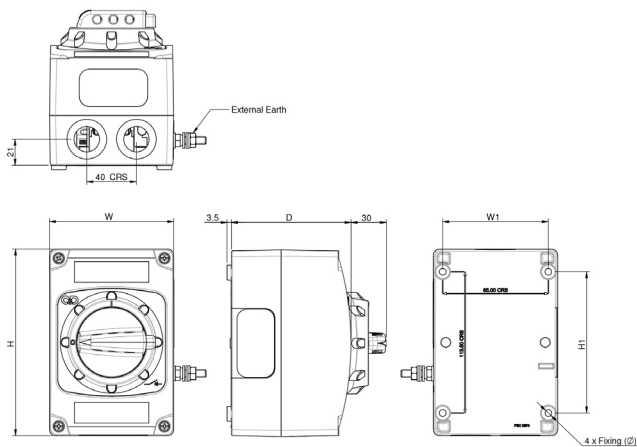

Size B22

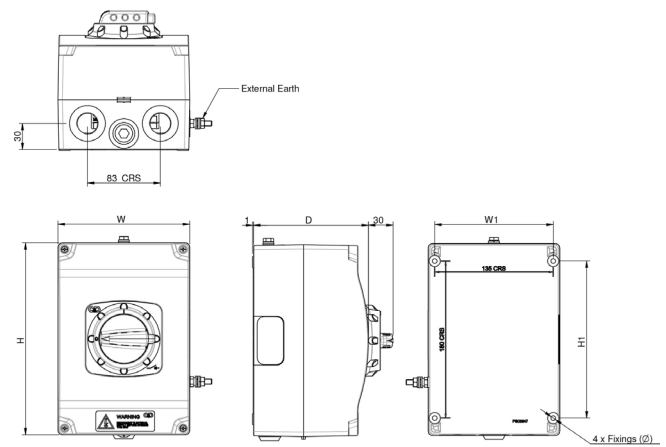

Sizes 1-6

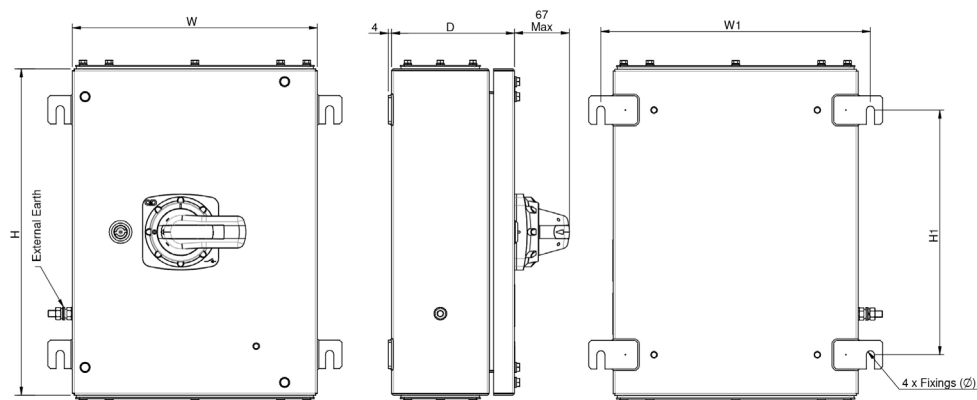

Encl. Size	Overall Dims.			Fixing Details		
	H	W	D	H1	W1	Ø
A22	150	100	96	113.5	85	5.5
B22	220	150	120	180	135	5.5
1	300	300	150	200	330	10
2	400	300	150	300	330	10
3	400	400	200	300	430	10
4	600	400	200	500	430	10
5	600	500	200	500	530	10
6	800	600	200	700	630	10

AUTOMATIC TRANSFER SWITCHES



Automatic Transfer Switches (ATS) are essential wherever substantial power must be maintained, whether it is to ensure people's safety in work or public space, or to maintain essential supplies to a vital process. The changeover device automatically operates the transition from the primary to the secondary power supply in the event of the loss of the primary supply to the building. The second source of power can either be from a generator or from an alternative/stand-by source.

Craig & Derricott offer a full range of Auto Transfer Switches suitable for all installations including life safety equipment. As a market leading specialist of Automatic Transfer Equipment, Craig & Derricott are here to help you. C&D have designed their ATS units to be operational in a variety of installations such as hospitals, stately homes, water distribution facilities, airports, data centres, shopping centres, offices, apartments and railway.

Our range covers current ratings from 32A to 800A and include models compliant to life safety standards BS8519:2020.





LOOSE PANEL AUTOMATIC TRANSFER SWITCHES (ATS)

This range of motorised panel automatic transfer switches are rated from 32A to 630A. These can be supplied in SPN (230V) and TPN (400V) AC 50/60Hz variants. Our ATS units are designed to allow safe automatic transfer of loads from a primary supply to a standby generator or secondary power supply. Applied standards: EN60947-6-1 PC type.

Each panel ATS switch comes standard with the following:

- LED status display and keypad – for ATS configuration.
- Lock off actuator for downstream maintenance.
- AC33B utilisation category.
- Generator Stop / Start delay functionality.
- Modbus communication.
- Aux power supply option 24V DC.

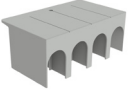
Loose Panel ATS							
Image	AC33 Rating	Cat. No.		Switch Size	Max Cable Size	Mounting CRS	Mounting Hole Dia.
		SPN	TPN				
	32-80A	ATS0802E	ATS0804E	230x125x130	25mm ²	212x100	M4
	100-125A	ATS1252E	ATS1254E	245x130x122	50mm ²	230x113	M4
	160-250A	ATS2502E	ATS2504E	295x175x175	120mm ²	275x152	M6
	400-630A	ATS6302E	ATS6304E	430x272x228	2x240mm ²	400x240	M8
Accessories							
Image	Description	Cat. No.		Size	Suitable for?		
	Remote Display Module	ATSDISPE		133x66x35	All		
	Terminal Shroud	ATS125SE		-	ATS1252E & ATS1254E		
		ATS250SE		-	ATS2502E & ATS2504E		
		ATS630SE		-	ATS6302E & ATS6304E		

STANDARD MOTORISED TYPE AUTOMATIC TRANSFER SWITCHES (ATS)

This range of motorised automatic transfer switches are rated from 32A to 630A. These can be supplied in SPN (230V) and TPN (400V) AC 50/60Hz variants. Our ATS units are designed to allow safe automatic transfer of loads from a primary supply to a standby generator or secondary power supply. Each ATS is supplied in a light grey (RAL 7035) sheet steel enclosure with removable gland plates, offering IP65 protection degree from dust and water ingress. Applied standards: EN60947-6-1 PC type.

Each panel ATS switch comes standard with the following:

- LED status display and keypad – for ATS configuration
- Lock off actuator for downstream maintenance.
- AC33B utilisation category.
- Generator Stop / Start delay functionality.
- Modbus communication.
- Aux power supply option 24V DC.
- ATS status is visible through a window supplied in the enclosure door.

Standard Motorised Type ATS								
Image	AC33 Rating	Cat. No.		Encl. Size	Encl. Material	Encl. Colour	IP Rating	Max Cable Size
		SPN	TPN					
	32A	ATS0322E000	ATS0324E000	400x400x200	Sheet Steel	RAL 7035	IP65	25mm ²
	45A	ATS0452E000	ATS0454E000	400x400x200	Sheet Steel	RAL 7035	IP65	25mm ²
	63A	ATS0632E000	ATS0634E000	400x400x200	Sheet Steel	RAL 7035	IP65	25mm ²
	80A	ATS0802E000	ATS0804E000	400x400x200	Sheet Steel	RAL 7035	IP65	25mm ²
	100A	ATS1002E000	ATS1004E000	400x400x200	Sheet Steel	RAL 7035	IP65	35mm ²
	125A	ATS1252E000	ATS1254E000	500x500x200	Sheet Steel	RAL 7035	IP65	35mm ²
	160A	ATS1602E000	ATS1604E000	600x600x300	Sheet Steel	RAL 7035	IP65	95mm ²
	250A	ATS2502E000	ATS2504E000	800x600x300	Sheet Steel	RAL 7035	IP65	95mm ²
	400A	ATS4002E000	ATS4004E000	1000x600x300	Sheet Steel	RAL 7035	IP65	2x240mm ²
	630A	ATS6302E000	ATS6304E000	1000x600x300	Sheet Steel	RAL 7035	IP65	2x240mm ²

STANDARD MOTORISED FORM 3 TYPE AUTOMATIC TRANSFER SWITCHES (ATS)

This range of form 3 motorised automatic transfer switches are rated from 32A to 630A. These can be supplied in SPN (230V) and TPN (400V) AC 50/60Hz variants. Our ATS units are designed to allow safe automatic transfer of loads from a primary supply to a standby generator or secondary power supply. Each ATS is supplied in a light grey (RAL 7035) sheet steel enclosure with removable gland plates, offering up to IP65 protection degree from dust and water ingress. Applied standards: EN60947-6-1 PC type, BS EN/IEC 61439-2, BS EN/IEC 60947-3.

Each panel ATS switch comes standard with the following:

- LED status display and keypad – for ATS configuration
- Lock off actuator for downstream maintenance.
- AC33B utilisation category.
- Generator Stop / Start delay functionality.
- Modbus communication.
- BMS connectivity.
- Aux power supply option 24V DC.
- Incoming isolators & outgoing terminals.
- Volt free status relays, mimic Modbus terminals for easy connection.

Form 3 Motorised Type ATS

Image	AC33 Rating	Cat. No.		Encl. Size	Encl. Material	Encl. Colour	IP Rating	Max Cable Size
		SPN	TPN					
	32A	ATS0322E500	ATS0324E500	500x500x200	Sheet Steel	RAL 7035	IP65	25mm ²
	45A	ATS0452E500	ATS0454E500	500x500x200	Sheet Steel	RAL 7035	IP65	25mm ²
	63A	ATS0632E500	ATS0634E500	600x600x200	Sheet Steel	RAL 7035	IP65	25mm ²
	80A	ATS0802E500	ATS0804E500	600x600x200	Sheet Steel	RAL 7035	IP65	25mm ²
	100A	ATS1002E500	ATS1004E500	600x600x200	Sheet Steel	RAL 7035	IP65	35mm ²
	125A	ATS1252E500	ATS1254E500	600x600x200	Sheet Steel	RAL 7035	IP65	35mm ²
	160A	ATS1602E500	ATS1604E500	800x600x300	Sheet Steel	RAL 7035	IP65	95mm ²
	250A	ATS2502E500	ATS2504E500	1000x800x300	Sheet Steel	RAL 7035	IP65	95mm ²
	400A	ATS4002E500	ATS4004E500	1200x1000x300	Sheet Steel	RAL 7035	IP55	2x240mm ²
	630A	ATS6302E500	ATS6304E500	1200x1000x300	Sheet Steel	RAL 7035	IP55	2x240mm ²

SINGLE LINE BYPASS MOTORISED FORM 3 TYPE AUTOMATIC TRANSFER SWITCHES (ATS)

This range of life safety form 3 motorised automatic transfer switches with no-break single line bypass, are rated from 32A to 630A. These can be supplied in SPN (230V) and TPN (400V) AC 50/60Hz variants. Our ATS units are designed to allow safe automatic transfer of loads from a primary supply to a standby generator or secondary power supply. Each ATS is supplied in a light grey (RAL 7035) sheet steel enclosure with removable gland plates, offering up to IP65 protection degree from dust and water ingress. Applied standards: EN60947-6-1 PC type, BS EN/IEC 61439-2, BS EN/IEC 60947-3, BS 8519:2020, BS9999:2017.

Each panel ATS switch comes standard with the following:

- LED status display and keypad – for ATS configuration
- Lock off actuator for downstream maintenance.
- AC33B utilisation category.
- Generator Stop / Start delay functionality.
- Modbus communication.
- BMS connectivity.
- Aux power supply option 24V DC.
- Incoming isolators & outgoing terminals.
- Volt free status relays, mimic Modbus terminals for easy connection.
- Single Line No-Break Bypass for maintenance, servicing, and repairs.

Form 3 Single Line Bypass Motorised Type ATS

Image	AC33 Rating	Cat. No.		Encl. Size	Encl. Material	Encl. Colour	IP Rating	Max Cable Size
		SPN	TPN					
	32A	ATS0322E530	ATS0324E530	800x600x300	Sheet Steel	RAL 7035	IP65	16mm ²
	45A	ATS0452E530	ATS0454E530	800x600x300	Sheet Steel	RAL 7035	IP65	16mm ²
	63A	ATS0632E530	ATS0634E530	800x600x300	Sheet Steel	RAL 7035	IP65	35mm ²
	80A	ATS0802E530	ATS0804E530	800x600x300	Sheet Steel	RAL 7035	IP65	35mm ²
	100A	ATS1002E530	ATS1004E530	1000x600x300	Sheet Steel	RAL 7035	IP65	50mm ²
	125A	ATS1252E530	ATS1254E530	1000x600x300	Sheet Steel	RAL 7035	IP65	50mm ²
	160A	ATS1602E530	ATS1604E530	1000x600x300	Sheet Steel	RAL 7035	IP65	50mm ²
	250A	ATS2502E530	ATS2504E530	1200x800x300	Sheet Steel	RAL 7035	IP65	95mm ²
	400A	ATS4002E630	ATS4004E630	1600x1000x400	Sheet Steel	RAL 7035	IP55	240mm ²
	630A	ATS6302E630	ATS6304E630	1800x1000x400	Sheet Steel	RAL 7035	IP55	2x240mm ²

DUAL LINE BYPASS MOTORISED FORM 3 TYPE AUTOMATIC TRANSFER SWITCHES (ATS)

This range of life safety form 3 motorised automatic transfer switches with no-break dual line bypass, are rated from 32A to 630A. These can be supplied in SPN (230V) and TPN (400V) AC 50/60Hz variants. Our ATS units are designed to allow safe automatic transfer of loads from a primary supply to a standby generator or secondary power supply. Each ATS is supplied in a light grey (RAL 7035) sheet steel enclosure with removable gland plates, offering up to IP65 protection degree from dust and water ingress. Applied Standards: EN60947-6-1 PC type, BS EN/IEC 61439-2, BS EN/IEC 60947-3, BS 8519:2020, BS9999:2017.

Each panel ATS switch comes standard with the following:

- LED status display and keypad – for ATS configuration.
- Lock off actuator for downstream maintenance.
- AC33B utilisation category.
- Generator Stop / Start delay functionality.
- Modbus communication.
- BMS connectivity.
- Aux power supply option 24V DC.
- Incoming isolators & outgoing terminals.
- Volt free status relays, mimic and Modbus terminals for easy connection.
- Dual Line No-Break Bypass for maintenance, servicing, and repairs (bypassing the primary or secondary supply).



Form 3 Dual Line Bypass Motorised Type ATS

Image	AC33 Rating	Cat. No.		Encl. Size	Encl. Material	Encl. Colour	IP Rating	Max Cable Size
		SPN	TPN					
	32A	ATS0322E540	ATS0324E540	800x600x300	Sheet Steel	RAL 7035	IP65	16mm ²
	45A	ATS0452E540	ATS0454E540	800x600x300	Sheet Steel	RAL 7035	IP65	16mm ²
	63A	ATS0632E540	ATS0634E540	1000x800x300	Sheet Steel	RAL 7035	IP65	35mm ²
	80A	ATS0802E540	ATS0804E540	1000x800x300	Sheet Steel	RAL 7035	IP65	35mm ²
	100A	ATS1002E540	ATS1004E540	1000x800x300	Sheet Steel	RAL 7035	IP65	50mm ²
	125A	ATS1252E540	ATS1254E540	1000x800x300	Sheet Steel	RAL 7035	IP65	50mm ²
	160A	ATS1602E540	ATS1604E540	1200x1000x300	Sheet Steel	RAL 7035	IP65	50mm ²
	250A	ATS2502E640	ATS2504E640	1600x1000x400	Sheet Steel	RAL 7035	IP55	95mm ²
	400A	ATS4002E640	ATS4004E640	1800x1000x400	Sheet Steel	RAL 7035	IP55	240mm ²
630A	ATS6302E640	ATS6304E640	2000x1600x500	Sheet Steel	RAL 7035	IP55	2x240mm ²	

MIMIC PANELS

Available to support the ATS units, we offer a range of remote status indication panels. These units are normally installed local to the buildings point of entry, allowing for an instant visual status of the ATS. Each unit is supplied with a brushed Stainless Steel (Grade 304) face plate, that can either be flush mounted to a 6/8way grid switch back box or provided with our surface mounting mild steel IP65 back box. All indication panels are made to meet standards: BS EN 60947-1. Other variants are available on request.

Mimic Panels

Image	Associated ATS Type	Cat. No	Encl. Size	Fascia Plate Material	Indication Panel Back box Type	IP Rating	Max Cable Size
	Standard ATS	ATSIP0	156x156x45	Stainless Steel	No Back box	--	2.5mm ²
		ATSIP0B0	156x156x45	Stainless Steel	Mild Steel Back box Black RAL 9005	IP65	2.5mm ²
	ATS with Single Line Bypass	ATSIP1	156x156x45	Stainless Steel	No Back box	--	2.5mm ²
		ATSIP1B0	156x156x45	Stainless Steel	Mild Steel Back box Black RAL 9005	IP65	2.5mm ²
	ATS with Dual Line Bypass	ATSIP2	156x156x45	Stainless Steel	No Back box	--	2.5mm ²
		ATSIP2B0	156x156x45	Stainless Steel	Mild Steel Back box Black RAL 9005	IP65	2.5mm ²

LIFE SAFETY FORM 4 TYPE 2 AUTOMATIC TRANSFER SWITCHES (ATS) WITH SINGLE OR DUAL LINE MAINTENANCE BYPASS - MOTORISED TYPE, CLASS PC

At the core of each system is a four-pole ABB OTM changeover device. Rated 230V or 400V AC, the life safety single line or dual line no-break bypass ATS, utilises a motorised changeover switch that provides all the essential requirements for automatically switching to a secondary power source. Units are rated from 32A to 63A with a rated frequency of 50/60Hz. The single or three phase ATS units allow automatic connection of a secondary electrical supply to a load upon failure of the primary supply.





The bypass function isolates the ATS by bypassing the 'S1' supply or (in the case of dual-line versions) the 'S2' supply directly to the outgoing load, enabling essential maintenance. The 'S1' supply will be bypassed with no-break in supply in accordance with life safety recommendations. The Key advantage is that both the 'S1' supply and 'S2' supply to the load can be maintained whilst service and repairs can be carried out on the ATS unit.

Supplied in Sheet Steel enclosures up to IP65 with a light grey (RAL 7035) paint finish, each enclosure comes standard with a removable glandplate(s). Each unit comes with a built-in controller designed to monitor the voltage of an incoming AC supply from two different sources. This could be from both generator or mains (utility), or a combination of both. The module monitors S1 (Source 1) and in the event of a failure issues a start command to S2 (Source 2). The main LED indicator lights show the status of the supplies. An auto / test switch is supplied with a set of 2 keys.

Incoming terminals or isolators are separated from each other and from the transfer switch using rigid metallic barriers in compliance with form 4, type 2 separation. Volt-free status relays are included within the ATS unit in order to connect to the BMS (building management system) and/or life safety systems installed within the building.

Each ATS unit comes standard with mimic terminals for easy connection to a remote mimic panel.

Optional modbus communication module can be requested within the ATS unit in order to connect to the BMS (building management system) and/or life safety systems installed within the building. Applied standards: BS EN / IEC 60947-6-1 & BS 8519:2020.

Life Safety Single Line Bypass								
Image	AC33 Rating	Cat. No.		Encl. Size	Encl. Material	Encl. Colour	IP Rating	Max Cable Size
		SPN	TPN					
Standard Life Safety Single Line Bypass ATS With Incoming Terminals								
	32A	ATS03229130	ATS03249130	800x600x300	Sheet Steel	RAL 7035	IP65	16mm ² Btm
	45A	ATS04529130	ATS04549130	800x600x300	Sheet Steel	RAL 7035	IP65	16mm ² Btm
	63A	ATS06329130	ATS06349130	1200x600x300	Sheet Steel	RAL 7035	IP65	50mm ² Btm
Standard Life Safety Single Line Bypass ATS With Incoming Isolators								
	32A	ATS03229230	ATS03249230	800x600x300	Sheet Steel	RAL 7035	IP65	16mm ² Btm
	45A	ATS04529230	ATS04549230	800x600x300	Sheet Steel	RAL 7035	IP65	16mm ² Btm
	63A	ATS06329230	ATS06349230	1200x600x300	Sheet Steel	RAL 7035	IP65	50mm ² Btm
Life Safety Dual Line Bypass								
Image	AC33 Rating	Cat. No.		Encl. Size	Encl. Material	Encl. Colour	IP Rating	Max Cable Size
		SPN	TPN					
Standard Life Safety Dual Line Bypass ATS With Incoming Terminals								
	32A	ATS03229140	ATS03249140	800x600x300	Sheet Steel	RAL 7035	IP65	16mm ² Btm
	45A	ATS04529140	ATS04549140	800x600x300	Sheet Steel	RAL 7035	IP65	16mm ² Btm
	63A	ATS06329140	ATS06349140	1200x800x300	Sheet Steel	RAL 7035	IP65	50mm ² Btm
Life Safety Dual Line Bypass ATS With Incoming Isolators								
	32A	ATS03229240	ATS03249240	800x600x300	Sheet Steel	RAL 7035	IP65	16mm ² Btm
	45A	ATS04529240	ATS04549240	800x600x300	Sheet Steel	RAL 7035	IP65	16mm ² Btm
	63A	ATS06329240	ATS06349240	1200x800x300	Sheet Steel	RAL 7035	IP65	50mm ² Btm

Note. The ATS units are not suitable for use with regenerative drive lifts.

LIFE SAFETY FORM 4 TYPE 2 AUTOMATIC TRANSFER SWITCHES (ATS) WITH SINGLE LINE MAINTENANCE BYPASS - SOLENOID TYPE CLASS PC

At the core of each system is a four-pole ABB TruOne changeover device. Rated 230V or 400V AC, the life safety single line no-break bypass ATS, utilises a solenoid changeover switch that provides all the essential requirements for automatically switching to a secondary power source. Units are rated from 32A to 800A with a rated frequency of 50/60Hz. The single or three phase ATS units allow automatic connection of a secondary electrical supply to a load upon failure of the primary supply.



The bypass function isolates the ATS by bypassing the 'S1' supply directly to the outgoing load, enabling essential maintenance. The 'S1' supply will be bypassed with no-break in supply in accordance with life safety recommendations. The key advantage is that the 'S1' supply to the load can be maintained whilst service and repairs can be carried out on the ATS unit.

Supplied in sheet steel enclosures up to IP65 with a light grey (RAL 7035) paint finish, each enclosure comes standard with a removable glandplate(s). Each unit comes with a built-in controller designed to monitor the voltage of an incoming AC supply from two different sources. This could be from both generator or mains (utility), or a combination of both. The module monitors S1 (Source 1) and in the event of a failure issues a start command to S2 (Source 2). The main LED indicator lights show the status of the supplies. An auto / test switch is supplied with a set of 2 keys.

Incoming terminals or isolators are separated from each other and from the transfer switch using rigid metallic barriers in compliance with form 4, type 2 separation. Volt-free status relays are included within the ATS unit in order to connect to the BMS (building management system) and/or life safety systems installed within the building.

Each ATS unit comes standard with mimic terminals for easy connection to a remote mimic panel.

Optional communication modules e.g. Modbus / Ethernet can be requested within the ATS unit in order to connect to the BMS (building management system) and/or life safety systems installed within the building. Applied standards: BS EN / IEC 60947-6-1 & BS 8519:2020.

Life Safety Single Line Bypass								
Image	AC33 Rating	Cat. No.		Encl. Size	Encl. Material	Encl. Colour	IP Rating	Max Cable Size
		SPN	TPN					
Life Safety Single Line Bypass ATS With Incoming Terminals								
	32A	ATS03225130	ATS03245130	1200x800x300	Sheet Steel	RAL 7035	IP65	16mm ² Btm
	45A	ATS04525130	ATS04545130	1200x800x300	Sheet Steel	RAL 7035	IP65	16mm ² Btm
	63A	ATS06325130	ATS06345130	1200x800x300	Sheet Steel	RAL 7035	IP65	50mm ² Btm
	100A	ATS10025130	ATS10045130	1200x800x300	Sheet Steel	RAL 7035	IP65	70mm ² Btm
	125A	ATS12525130	ATS12545130	1200x800x300	Sheet Steel	RAL 7035	IP65	70mm ² Btm
	160A	ATS16025330	ATS16045330	1800x1000x400	Sheet Steel	RAL 7035	IP55	185mm ² Top
	250A	ATS25025330	ATS25045330	1800x1000x400	Sheet Steel	RAL 7035	IP55	185mm ² Top
	400A	ATS40025330	ATS40045330	1800x1000x400	Sheet Steel	RAL 7035	IP55	240mm ² Top
	630A	ATS63025330	ATS63045330	2000x1200x400	Sheet Steel	RAL 7035	IP55	2x240mm ² Top
	800A	ATS80025330	ATS80045330	2000x1200x400	Sheet Steel	RAL 7035	IP55	2x240mm ² Top
Life Safety Single Line Bypass ATS With Incoming Isolators								
	32A	ATS03225230	ATS03245230	1200x800x300	Sheet Steel	RAL 7035	IP65	16mm ² Btm
	45A	ATS04525230	ATS04545230	1200x800x300	Sheet Steel	RAL 7035	IP65	16mm ² Btm
	63A	ATS06325230	ATS06345230	1200x800x300	Sheet Steel	RAL 7035	IP65	50mm ² Btm
	100A	ATS10025230	ATS10045230	1200x800x300	Sheet Steel	RAL 7035	IP65	70mm ² Btm
	125A	ATS12525230	ATS12545230	1200x800x300	Sheet Steel	RAL 7035	IP65	70mm ² Btm
	160A	ATS16025430	ATS16045430	1800x1000x400	Sheet Steel	RAL 7035	IP55	185mm ² Top
	250A	ATS25025430	ATS25045430	1800x1000x400	Sheet Steel	RAL 7035	IP55	185mm ² Top
	400A	ATS40025430	ATS40045430	1800x1000x400	Sheet Steel	RAL 7035	IP55	240mm ² Top
	630A	ATS63025430	ATS63045430	2000x1200x400	Sheet Steel	RAL 7035	IP55	2x240mm ² Top
	800A	ATS80025430	ATS80045430	2000x1200x400	Sheet Steel	RAL 7035	IP55	2x240mm ² Top

LIFE SAFETY FORM 4 TYPE 2 AUTOMATIC TRANSFER SWITCHES (ATS) WITH DUAL LINE MAINTENANCE BYPASS - SOLENOID TYPE CLASS PC

At the core of each system is a four-pole ABB TruOne changeover device. Rated 230V or 400V AC, the life safety dual line no-break bypass ATS, utilises a solenoid changeover switch that provides all the essential requirements for automatically switching to a secondary power source. Units are rated from 32A to 800A with a rated frequency of 50/60Hz. The single or three phase ATS units allow automatic connection of a secondary electrical supply to a load upon failure of the primary supply.



The bypass function isolates the ATS by bypassing the 'S1' supply or the 'S2' supply directly to the outgoing load, enabling essential maintenance. The 'S1' supply will be bypassed with no-break in supply in accordance with life safety recommendations. The key advantage is that both the 'S1' supply and 'S2' supply to the load can be maintained whilst service and repairs can be carried out on the ATS unit.

Supplied in sheet steel enclosures up to IP65 with a light grey (RAL 7035) paint finish, each enclosure comes standard with a removable glandplate(s). Each unit comes with a built-in controller designed to monitor the voltage of an incoming AC supply from two different sources. This could be from both generator or mains (utility), or a combination of both. The module monitors S1 (Source 1) and in the event of a failure issues a start command to S2 (Source 2). The main LED indicator lights show the status of the supplies. An auto / test switch is supplied with a set of 2 keys.

Incoming terminals or isolators are separated from each other and from the transfer switch using rigid metallic barriers in compliance with form 4, type 2 separation. Volt-free status relays are included within the ATS unit in order to connect to the BMS (building management system) and/or life safety systems installed within the building.

Each ATS unit comes standard with mimic terminals for easy connection to a remote mimic panel.

Optional communication modules e.g. Modbus / Ethernet can be requested within the ATS unit in order to connect to the BMS (building management system) and/or life safety systems installed within the building. Applied standards: BS EN / IEC 60947-6-1 & BS 8519:2020.

Life Safety Dual Line Bypass								
Image	AC33 Rating	Cat. No.		Encl. Size	Encl. Material	Encl. Colour	IP Rating	Max Cable Size
		SPN	TPN					
Life Safety Dual Line Bypass ATS With Incoming Terminals								
	32A	ATS03225140	ATS03245140	1200x800x300	Sheet Steel	RAL 7035	IP65	16mm ² Btm
	45A	ATS04525140	ATS04545140	1200x800x300	Sheet Steel	RAL 7035	IP65	16mm ² Btm
	63A	ATS06325140	ATS06345140	1200x800x300	Sheet Steel	RAL 7035	IP65	50mm ² Btm
	100A	ATS10025140	ATS10045140	1200x800x300	Sheet Steel	RAL 7035	IP65	70mm ² Btm
	125A	ATS12525140	ATS12545140	1200x800x300	Sheet Steel	RAL 7035	IP65	70mm ² Btm
	160A	ATS16025340	ATS16045340	1800x1000x400	Sheet Steel	RAL 7035	IP55	185mm ² Top
	250A	ATS25025340	ATS25045340	1800x1000x400	Sheet Steel	RAL 7035	IP55	185mm ² Top
	400A	ATS40025340	ATS40045340	1800x1000x400	Sheet Steel	RAL 7035	IP55	240mm ² Top
	630A	ATS63025340	ATS63045340	2000x1200x400	Sheet Steel	RAL 7035	IP55	2x240mm ² Top
	800A	ATS80025340	ATS80045340	2000x1200x400	Sheet Steel	RAL 7035	IP55	2x240mm ² Top
Life Safety Dual Line Bypass ATS With Incoming Isolators								
	32A	ATS03225240	ATS03245240	1200x800x300	Sheet Steel	RAL 7035	IP65	16mm ² Btm
	45A	ATS04525240	ATS04545240	1200x800x300	Sheet Steel	RAL 7035	IP65	16mm ² Btm
	63A	ATS06325240	ATS06345240	1200x800x300	Sheet Steel	RAL 7035	IP65	50mm ² Btm
	100A	ATS10025240	ATS10045240	1200x800x300	Sheet Steel	RAL 7035	IP65	70mm ² Btm
	125A	ATS12525240	ATS12545240	1200x800x300	Sheet Steel	RAL 7035	IP65	70mm ² Btm
	160A	ATS16025440	ATS16045440	1800x1000x400	Sheet Steel	RAL 7035	IP55	185mm ² Top
	250A	ATS25025440	ATS25045440	1800x1000x400	Sheet Steel	RAL 7035	IP55	185mm ² Top
	400A	ATS40025440	ATS40045440	1800x1000x400	Sheet Steel	RAL 7035	IP55	240mm ² Top
	630A	ATS63025440	ATS63045440	2000x1600x500	Sheet Steel	RAL 7035	IP55	2x240mm ² Top
	800A	ATS80025440	ATS80045440	2000x1600x500	Sheet Steel	RAL 7035	IP55	2x240mm ² Top

PANEL SWITCHES

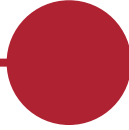

Craig & Derricott has a range of products designed specifically for control panel and switchboard construction.

Most panels require a means of electrical isolation and the i-switch range can offer variants in the range of 25A- 1250A. All handle assemblies employ safety features with an override facility for testing or emergency situations.

A choice of shaft lengths, auxiliary contacts & shields provide the flexibility to suit most applications.



PANEL ISOLATORS

Craig & Derricott offer a range of control panel isolation equipment for panel mounting.

The compact range is available 25A to 200A. Each AC23A isolator has IP2X terminal protection and can be either DIN rail or base mounted. All come supplied with a door interlocking operating handle and a standard length shaft of 100mm. A compact range of switch disconnectors with the capacity to add auxiliary and neutral block options to the basic load break switch block. Incoming terminal covers are supplied on size A3 frames.

The standard range is available 100A to 1250A. Each AC23A isolator has IP2X terminal protection and can be either DIN rail or base mounted. All come supplied with a door interlocking operating handle and a standard length shaft of 200mm. A range of switch disconnectors with the capacity to add auxiliary and neutral block options to the basic load break switch block. All isolators are supplied with direct lug connections onto plated copper palms.

The changeover range is available 63A to 630A. Each AC23A isolator has IP2X terminal protection and is supplied with a door interlocking operating handle and a standard length shaft of 200mm. A compact range of switches with the capacity to add auxiliary and neutral block options to the basic load break switch block. All isolators are supplied with direct lug connections onto plated copper palms.

'B' = Black Handle. For Red Handle, replace B with R in the Cat. No. E.g. SD00253R

Compact Range						
Image	Rating	Format	Cat. No	Frame Size	IP Rating	Std Shaft Length
	25A	3P	SD00253B	A0	IP65	100mm
		6P	SD00256B	A0-A0		
	32A	3P	SD00323B	A0	IP65	100mm
		6P	SD00326B	A0	IP65	100mm
	40A	3P	SD00403B	A0	IP65	100mm
		6P	SD00406B	A1-A1		
	63A	3P	SD00633B	A1	IP65	100mm
		6P	SD00636B	A1-A1		
	80A	3P	SD00803B	A1	IP65	100mm
		6P	SD00806B	A1	IP65	100mm
	100A	3P	SDC01003B	A2	IP65	100mm
		6P	SDC01006B	A2-A2		
125A	3P	SDC01253B	A2	IP65	100mm	
	6P	SDC01256B	A2-A2			
160A	3P	SDC01603B	A2	IP65	100mm	
	6P	SDC01606B	A2-A2			
200A	3P	SDC02003B	A3	IP65	100mm	
	6P	SDC02006B	A3	IP65	100mm	
Standard Range						
	100A	3P	SD01003B	B1	IP65	200mm
		4P	SD01004B			
	125A	3P	SD01253B	B1	IP65	200mm
		4P	SD01254B			
	160A	3P	SD01603B	B1	IP65	200mm
		4P	SD01604B			
	200A	3P	SD02003B	B2	IP65	200mm
		4P	SD02004B			
	250A	3P	SD02503B	B2	IP65	200mm
		4P	SD02504B			
	400A	3P	SD04003B	B3	IP65	200mm
		4P	SD04004B			
	630A	3P	SD06303B	B3	IP65	200mm
		4P	SD06304B			
	800A	3P	SD08003B	B3	IP65	200mm
		4P	SD08004B			
1000A	3P	SD10003B	B4	IP65	200mm	
	4P	SD10004B				
1250A	3P	SD12503B	B4	IP65	200mm	
	4P	SD12504B				
Changeover Range						
	63A	4P	SCOD00634B	C1C	IP65	200mm
	100A	4P	SCOD01004B	C1C	IP65	200mm
	125A	4P	SCOD01254B	C2C	IP65	200mm
	160A	4P	SCOD01604B	C2C	IP65	200mm
	200A	4P	SCOD02004B	C2C	IP65	200mm
	250A	4P	SCOD02504B	C2	IP65	200mm
	400A	4P	SCOD04004B	C3	IP65	200mm
	630A	4P	SCOD06304B	C3	IP65	200mm

PANEL ISOLATORS

Craig & Derricott offer a range of control panel isolation equipment for panel mounting.

The fuse combination range is available 32A to 630A. Each AC23A switch has IP2X terminal protection and are suitable for standard IEC/BS EN 60269 (BS88) fuse links. All come supplied with a door interlocking operating handle with an override facility and a standard length shaft of 200mm. A compact range of switches with the capacity to add auxiliary and neutral block options to the basic load break switch block. Incoming terminal covers are supplied on size A3 frames.

The PV range is available 16A to 40A. Solar power is an environmentally friendly method of producing electricity and is achieved using Photovoltaic (PV) cells that capture sunlight and convert it to electricity. By combining cells into an array, different voltages and current combinations can be achieved. Once installed an array will continue to generate voltage and current and it is therefore essential to isolate the array in the event of a fault or for maintenance purposes. To enable this Craig & Derricott have developed a range of DC Switch Disconnectors to manage this specific application.

'B' = Black Handle. For Red Handle, replace B with R in the Cat. No. E.g. SDF00253R

*1 Designed to isolate twin arrays

Fuse Combination Range

Image	Rating	Format	Cat. No	Frame Size	IP Rating	Std Shaft Length
	32A	3P+N	SDF00323NB	D1	IP65	200mm
		3P+NL	SDF00323NLB			
	63A	3P+N	SDF00633NB	D1	IP65	200mm
		3P+NL	SDF00633NLB			
	100A	3P+N	SDF01003NB	D2	IP65	200mm
		3P+NL	SDF01003NLB			
	125A	3P+N	SDF01253NB	D2	IP65	200mm
		3P+NL	SDF01253NLB			
	160A	3P+N	SDF01603NB	D3	IP65	200mm
		3P+NL	SDF01603NLB			
	200A	3P+N	SDF02003NB	D4	IP65	200mm
		3P+NL	SDF02003NLB			
	250A	3P+N	SDF02503NB	D4	IP65	200mm
		3P+NL	SDF02503NLB			
	315A	3P+N	SDF03153NB	D5	IP65	200mm
		3P+NL	SDF03153NLB			
	400A	3P+N	SDF04003NB	D5	IP65	200mm
		3P+NL	SDF04003NLB			
630A	3P+N	SDF06303NB	D6	IP65	200mm	
	3P+NL	SDF06303NLB				

Photovoltaic (PV) Range

Image	Rating	Format	Cat. No	Max. DC Voltage	IP Rating	Std Shaft Length
	16A	DC 2P	SPV162	1,000V	IP65	200mm
		DC 4P	SPV164	1,500V		
		Twin Array DC 2x 2P	SPV1622*1	1,000V		
	25A	DC 2P	SPV252	1,000V	IP65	200mm
		DC 3P	SPV253	1,000V		
		DC 4P	SPV254	1,000V		
	32A	Twin Array DC 2x 2P	SPV2522*1	1,500V	IP65	200mm
		DC 2P	SPV322	600V		
		DC 3P	SPV323	1,000V		
		DC 4P	SPV324	1,500V		
	40A	Twin Array DC 2x 2P	SPV322*1	600V	IP65	200mm
		DC 2P	SPV402	300V/400V		
		DC 3P	SPV403	800V		
		DC 4P	SPV404	1,500V		
Twin Array DC 2x 2P		SPV4022*1	300V/400V			



















PANEL ISOLATOR ACCESSORIES

All of the accessories listed below can be retrofitted. One block can be fitted either side of the main assembly on all of the 3 pole switch interiors.

Fuse Links		
Description	Bussman Cat. No	Cat. No.
32A Fuse Link For BS Fuse Format A2- A3. Fuse Fixing CRS 73mm nom.	AA032	SFL32
63A Fuse Link For BS Fuse Format A2- A3. Fuse Fixing CRS 73mm nom.	BA063	SFL63
100A Fuse Link For BS Fuse Format A4. Fuse Fixing CRS 94mm nom.	CE0100	SFL100
125A Fuse Link For BS Fuse Format A4. Fuse Fixing CRS 94mm nom.	DE0125	SFL125
160A Fuse Link For BS Fuse Format B1- B2. Fuse Fixing CRS 111mm nom.	DD160	SFL160
200A Fuse Link For BS Fuse Format B1- B2. Fuse Fixing CRS 111mm nom.	DD200	SFL200
250A Fuse Link For BS Fuse Format B1- B2. Fuse Fixing CRS 111mm nom.	ED250	SFL250
315A Fuse Link For BS Fuse Format B1- B4. Fuse Fixing CRS 111mm nom.	ED315	SFL315
400A Fuse Link For BS Fuse Format B1- B4. Fuse Fixing CRS 111mm nom.	ED400	SFL400
630A Fuse Link For BS Fuse Format C1- C3. Fuse Fixing CRS 133/184mm nom.	FF630	SFL630
Auxiliary Contacts		
Description	Cat. No.	
Auxiliary Contact- 2 Early break for Compact Switch Range	SAUX2EB	
Auxiliary Contact- 1 N/O + 1 N/C for Compact Switch Range	SAUXCO	
25A- 40A Compact Neutral (Unswitched) for Compact Switch Range	SNLC40	
63A Neutral (Unswitched) for Compact Switch Range	SNL63	
80A Neutral (Unswitched) for Compact Switch Range	SNL80	
100A Neutral (Unswitched) for Compact Switch Range	SNL100	
125A Neutral (Unswitched) for Compact Switch Range	SNL125	
160A Neutral (Unswitched) for Compact Switch Range	SNL160	
200A Neutral (Unswitched) for Compact Switch Range	SNL200	
25A Neutral (Switched) for Compact Switch Range	SSP25	
40A Neutral (Switched) for Compact Switch Range	SSP40	
63A Neutral (Switched) for Compact Switch Range	SSP63	
80A Neutral (Switched) for Compact Switch Range	SSP80	
100A Neutral (Switched) for Compact Switch Range	SSP100	
125A Neutral (Switched) for Compact Switch Range	SSP125	
160A Neutral (Switched) for Compact Switch Range	SSP160	
200A Neutral (Switched) for Compact Switch Range	SSP200	
Auxiliary Contact For 100A- 160A for Standard Switch & Fuse Combination Units Range	SAUXKITA	
Auxiliary Contact For 200A- 250A for Standard Switch Range	SAUXKITB	
Auxiliary Contact For 400A- 800A for Standard Switch & Fuse Combination Units Range	SAUXKITC	
Auxiliary Contact For 1000A- 1250A for Standard Switch & Fuse Combination Units Range	SAUXKITD	
Terminal Covers		
Set of 4 Terminal Covers For 200A Standard Switch & Fuse Combination Units Range	STS1	
Set of 4 Terminal Covers For 250A- 400A Standard Switch & Fuse Combination Units Range	STS2	
Set of 4 Terminal Covers For 630A Fuse Combination Units Range	STS3	
Set of 4 Terminal Covers For 630A Standard Switch Range	STS4	
Handles (Capable of being locked with up to three individual padlocks)		
Handle assembly supplied with the 'A0' & 'A1' frame sizes.	SDH1	
Handle assembly supplied with the 'A2' & 'A3' frame sizes.	SDH2	
Handle assembly supplied with the 'C1C & C2C' frame sizes.	SDH3	
Handle assembly supplied with the 'C2' & 'C3' frame size.	SDH4	
Handle assembly supplied with the 'C2' & 'C3' frame size.	SDH6	
Handle assembly supplied with the 'C2' & 'C3' frame size.	SDH7	
Adjustable Shafts		
200mm Shaft for 25A-80A Compact Switch Range	SSH2	
400m Shaft for 100A-160A Standard Switch Range & 32A-160A Fuse Combination Units Range	SSH13	
400m Shaft for 200A-250A Standard Switch Range & 63A-100A Changeover Range	SSH14	
400m Shaft for 400A-1250A Standard, Switch Range 200A-630A Fuse Combination Units & 250A-630A Changeover Range	SSH15	
200mm Shaft for 100A-200A Compact Switch Range	SSH17	
400mm Shaft for 125A-200A Changeover Range	SSH18	



















TECHNICAL SPECIFICATION

Data supplied against tests to BS EN 60947-3. *All AC21, AC22 & AC23 tests carried out at 415V.

Compact Range													
Application	Sym	Unit	Category	25	32	40	63	80	100	125	160	200	
Rated thermal current	I_{th}	A		25	32	40	63	80	100	125	160	200	
Rated insulation voltage	U_i	V		690	690	690	690	690	1000	1000	1000	1000	
Rated impulse voltage	U_{imp}	kV		6	6	6	6	6	8	8	8	8	
Rated operational current (AC)	I_e	A	400V AC21A	25	32	40	63	80	100	125	160	200	
			400V AC22A	-	-	-	-	-	100	125	160	200	
			400V AC23A	21	29	29	48	56	100	111	132	132	
Rated operational current (DC) (/poles in series)	I_e	A	Up to 48V DC21A	25/1	32/1	40/1	63/1	80/1	-	-	-	-	
			220V DC21A	25/3	32/3	40/3	63/4	80/4	-	-	-	-	
			Up to 48V DC22A	-	-	-	-	-	-	-	-	-	-
			220V DC22A	-	-	-	-	-	-	-	-	-	-
			Up to 48V DC23A	-	-	-	-	-	-	-	-	-	-
			220V DC23A	-	-	-	-	-	-	-	-	-	-
Rated operational power	P_e	kW	400/415V AC23A	11	15	15	25	30	59	63	75	75	
Short circuit making capacity	I_{cm}	kA	Peak value	1.2	1.4	1.4	2.9	3.0	3.7	4.0	5.0	5.0	
Short circuit withstand (1sec)	I_{cw}	kA	rms value	0.5	0.6	0.6	1.3	1.4	2.6	2.8	3.0	3.0	
Min. mechanical endurance	-	-	Operations	250 x 10 ³	250 x 10 ³	250 x 10 ³	250 x 10 ³	250 x 10 ³	50 x 10 ³	50 x 10 ³	50 x 10 ³	50 x 10 ³	
Min. electrical endurance	-	-	415V at 0.65 pf	-	-	-	-	-	-	-	-	-	
Connecting capacity	-	-	Terminal type										
	mm ²	Min/Max		2.5/10	2.5/10	2.5/10	2.5/25	2.5/25	10/70	10/70	10/70	-	
	mm	Stud/Cu palm width		-	-	-	-	-	-	-	-	8/20	
	Nm	Tightening torque		1.2	1.2	1.2	1.2	1.2	5	5	5	10	
Standard Range													
Application	Sym	Unit	Category	100	125	160	200	250	400	630	800	1000	1250
Rated thermal current	I_{th}	A		115	125	160	200	270	500	630	720	1000	1250
Rated insulation voltage	U_i	V		750	750	750	1000	1000	1000	1000	1000	1000	1000
Rated impulse voltage	U_{imp}	kV		8	8	8	12	12	12	12	12	8	8
Rated operational current (AC)	I_e	A	400V AC21A	100*	125*	160*	200*	250*	400*	630*	800*	1000*	1250*
			400V AC22A	100*	125*	160*	200*	250*	400*	630*	800*	1000*	1250*
			400V AC23A	100*	125*	135*	200*	250*	400*	630*	720*	-	-
Rated operational current (DC) (/poles in series)	I_e	A	Up to 48V DC21A	100/2	125/2	160/2	200/2	250/2	400/2	630/1	800/1	1000/1	1250/1
			220V DC21A	100/3	125/3	160/3	200/2	250/2	400/2	630/2	800/2	1000/3	1250/3
			Up to 48V DC22A	100/2	125/2	160/2	200/2	250/2	400/1	630/1	800/1	-	-
			220V DC22A	100/3	125/3	160/3	200/2	250/2	400/2	630/2	800/2	-	-
			Up to 48V DC23A	100/2	125/2	160/2	200/2	250/2	400/1	630/1	800/1	-	-
			220V DC23A	100/3	125/3	160/3	200/2	250/2	400/2	630/2	630/2	-	-
Rated operational power	P_e	kW	400/415V AC23A	37	45	75	110	132	200	315	355	400	500
Short circuit making capacity	I_{cm}	kA	Peak value	7	7	7	35	35	65	80	80	105	105
Short circuit withstand (1sec)	I_{cw}	kA	rms value	5	5	5	8	8	17	17	17	50	50
Min. mechanical endurance	-	-	Operations	20 x 10 ³	20 x 10 ³	20 x 10 ³	16 x 10 ³	16 x 10 ³	10 x 10 ³	10 x 10 ³	10 x 10 ³	6 x 10 ³	6 x 10 ³
Min. electrical endurance	-	-	415V at 0.65 pf	5,000	5,000	1,000	1,000	1,000	1,000	500	500	500	500
Connecting capacity	-	-	Terminal type										
	mm ²	Min/Max		-	-	-	-	-	-	-	-	-	
	mm	Stud/Cu palm width		8x25	8x25	8x25	8x25	10x30	10x40	12x40	12x40	12x60	12/60
	Nm	Tightening torque		10	10	10	10	30	30	50	50	50	50

TECHNICAL SPECIFICATION

Data supplied against tests to BS EN 60947-3. *All AC21, AC22 & AC23 tests carried out at 415V.

Changeover Range													
Application	Sym	Unit	Category	63	100	125	160	200	250	400	630		
Rated thermal current	I_{the}	A		63	100	125	160	200	250	400	630		
Rated insulation voltage	U_i	V		750	750	1000	1000	1000	1000	1000	1000		
Rated impulse voltage	U_{imp}	kV		6	6	6	6	6	12	12	12		
Rated operational current	I_e	A	415V AC22A	63	100	125	160	200	250	400	630		
Rated making capacity (AC23A)		A	415V, 0.35 pf	630	630	1,250	1,600	2,000	2,500	4,000	6,300		
Rated breaking capacity (AC23A)		A	415V, 0.35 pf	504	504	1,000	1,280	1,600	2,000	3,200	5,040		
Short circuit current		kA	rms (with fuses)	80	80	80	80	80	100	100	80		
Rated S/C making capacity		kA	Peak	15	15	20	20	20	30	40	50		
Min. mechanical endurance		-	Operations	20,000	20,000	10,000	10,000	10,000	10,000	10,000	10,000		
Min. electrical endurance		-	415V at 0.65 pf	2,500	1,500	1,000	1,000	1,000	1,000	1,000	500		
Connecting capacity		-	Terminal type										
		mm ²	Max	35	35	95	95	95	240	300	400		
		mm	Stud/Cu palm width	6/12	6/12	8/22	8/22	8/22	10/25	10/25	12/50		
		Nm	Tightening torque	3	3	10	10	10	30	30	50		
Fuse Combination Range													
Application	Sym	Unit	Category	32	63	100	125	160	200	250	315	400	630
Rated thermal current	I_{the}	A		32	63	100	125	160	200	250	315	400	630
Rated insulation voltage	U_i	V		750	750	750	750	750	750	750	750	750	750
Rated impulse voltage	U_{imp}	kV		12	12	12	12	12	12	12	12	12	12
Rated operational current	I_e	A	415V AC23A	32	63	100	125	160	200	250	315	400	630
			220V DC23A	-	-	100	125	160	200	250	315	400	630
Rated making capacity (AC23A)		A	415V, 0.35 pf	320	630	1,000	1,250	1,600	2,000	2,500	3,150	4,000	6,300
Rated breaking capacity (AC23A)		A	415V, 0.35 pf	256	504	800	1,000	1,280	1,600	2,000	2,520	3,200	5,040
Rated conditional (Fused) short circuit		kA	S/C current rms	80	80	80	80	80	80	80	80	80	80
		A	back-up fuse	32	63	100	125	160	200	250	315	400	630
Min. mechanical endurance		-	Operations	25,000	25,000	15,000	15,000	15,000	10,000	10,000	10,000	10,000	6,000
Min. electrical endurance		-	415V at 0.65 pf	1,500	1,500	1,000	1,000	1,000	1,000	1,000	1,000	1,000	1,000
BS fuse format				A2	A2	A4	A4	B1, B2	B1, B2	B1, B2	B1, B4	B1, B4	C1, C3
Connecting capacity		-	Terminal type										
		mm ²	Min/Max	16	25	95	95	120	150	185	240	300	400
		mm	Stud/Cu palm width	-	-	8x20	8x20	8x20	10x25	10x25	10x25	10x25	12x50
		Nm	Tightening torque	2.5	2.5	10	10	10	30	30	30	30	50

TECHNICAL SPECIFICATION

Data supplied against tests to BS EN 60947-3. *All AC21, AC22 & AC23 tests carried out at 415V.

1 = Pollution Degree 3
2 = Pollution Degree 2

PV Switch Disconnecter Units																	
Application	Category	Unit	16A 2P	16A 4P	16A 2P x2	25A 2P	25A 3P	25A 4P	25A 2P x2	32A 2P	32A 3P	32A 4P	32A 2P x2	40A 2P	40A 3P	40A 4P	40A 2P x2
Rated thermal current	I_{the}	A	16			25			32			40					
Rated insulation voltage	U_i	V	1,000 ¹			1,000 ¹			1,000 ¹			1,000 ¹					
			1,500 ²			1,500 ²			1,500 ²			1,500 ²					
Rated impulse withstand volt.	U_{imp}	kV	8			8			8			8					
Rated operational current (DC21B)	I_e	300V (A)	16	16	16	25	25	25	25	32	32	32	32	40	40	40	40
		400V (A)	16	16	16	25	25	25	25	32	32	32	32	40	40	40	40
		600V (A)	16	16	16	25	25	25	25	32	32	32	32	-	40	40	-
		800V (A)	16	16	16	25	25	25	25	-	32	32	-	-	40	40	-
		1,000V (A)	16	16	16	16	25	25	16	-	32	32	-	-	-	40	-
		1,200V (A)	-	16	-	-	-	20	-	-	-	25	-	-	-	32	-
		1,500V (A)	-	16	-	-	-	16	-	-	-	20	-	-	-	25	-
Mechanical life		Ops	15,000			15,000			15,000			15,000					
Rated short-time withstand current	I_{cw}	1s	500			500			500			500					
Short circuit making capacity	I_{cm}	A	550			550			550			550					
Terminal type																	
Terminal tightening torque		Nm	1.2			1.2			1.2			1.2					
Conductor size	Max r/f	2x	mm2	10/6			10/6			10/6			10/6				
			AWG	8/10			8/10			8/10			8/10				
r = rigid f = flexible	Min r/f	2x	mm2	1.5/1.5			1.5/1.5			1.5/1.5			1.5/1.5				
			AWG	16/16			16/16			16/16			16/16				

PHOTOVOLTAIC (PV) RANGE

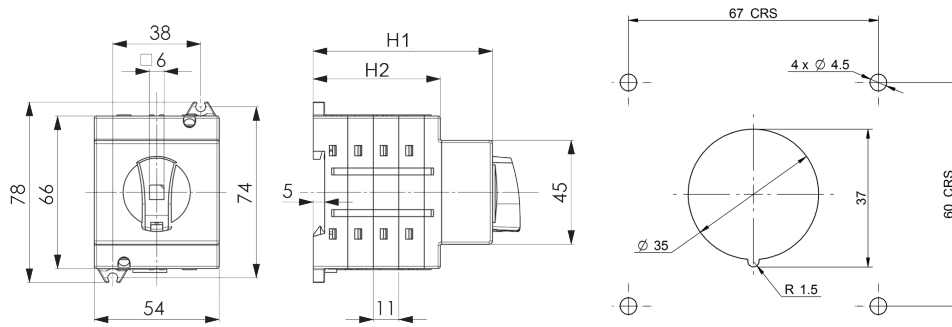

Rating	Format	H1	H2
16A	2P	50.5	28
	4P & Twin Array	72.5	50
25A	2P	50.5	28
	3P	61.5	39
32A	4P & Twin Array	72.5	50
	2P	50.5	28
	3P	61.5	39
40A	4P & Twin Array	72.5	50
	2P	50.5	28
	3P	61.5	39
	4P & Twin Array	72.5	50

COMPACT RANGE

A0 Size (25A- 40A) - x1 = n/a | x2= 105-180 | x3 = 105-280

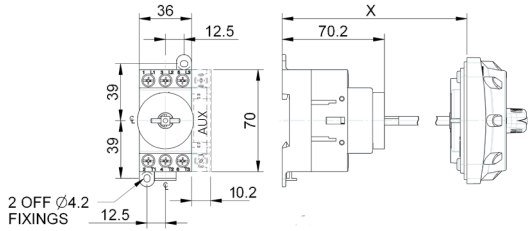

A0-A0 Size (6 pole 25A) - x1 = 98 | x2= 116-191 | x3 = 116-291

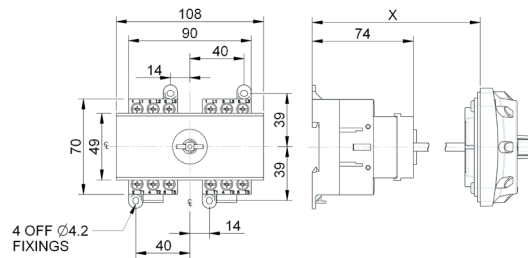

A1 Size (63A- 80A) - x1 = 98 | x2= 110-185 | x3 = 110-285

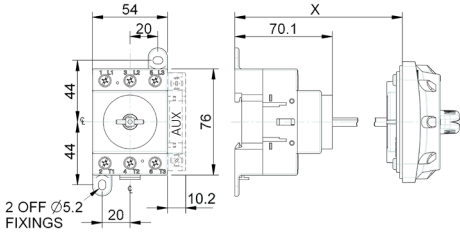

A1-A1 Size (6 pole 40A-80A) - x1 = 98 | x2= 116-191 | x3 = 116-291

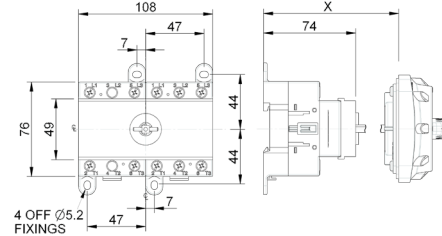

A2 Size (100A- 160A) - x1 = 121-166 | x2= n/a | x3 = 121-235

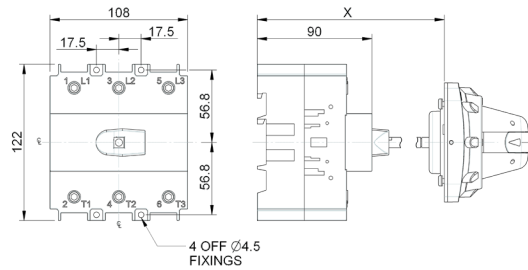

A2-A2 Size (6 pole 100A-160A) - x1 = 121-166 | x2= n/a | x3 = 121-235

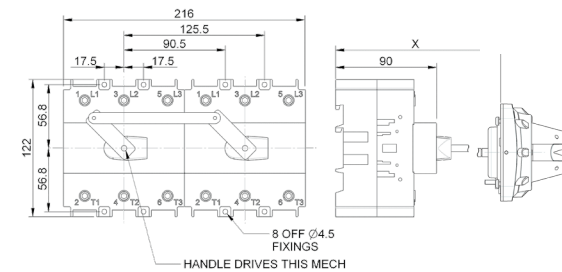

A3 Size (200A) - x1 = 121-166 | x2= n/a | x3 = 121-235

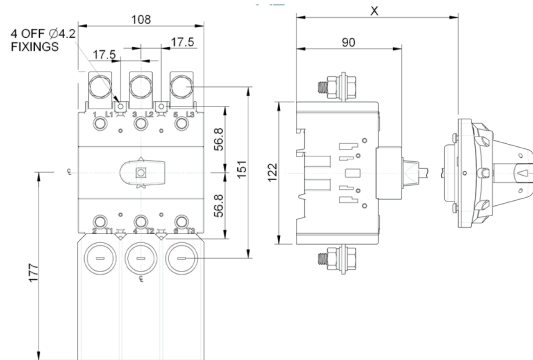

A3 Size (6 pole 200A) - x1 = 121-166 | x2= n/a | x3 = 121-235

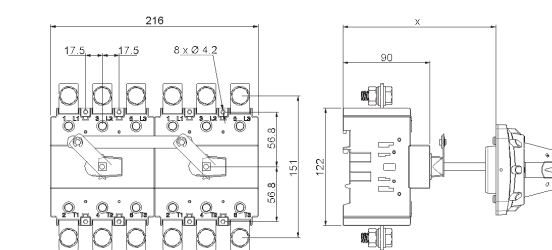

Compact Range

x1 = Min. & Max. (mm) (without extension shaft)

x2 = Min. & Max. (mm) with 100mm shaft extension

x3 = Min. & Max. (mm) with 200mm shaft extension

STANDARD RANGE

B1 Size (100A- 160A) - x3 = 156-251 | x4= 156-351

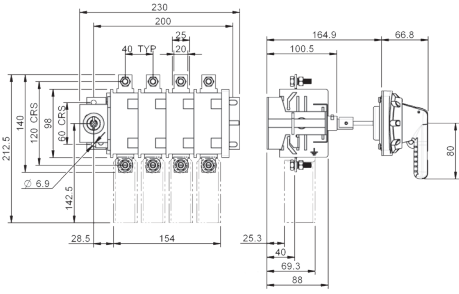

B2 Size (200A- 250A) - x3 = 158-254 | x4= 158-354

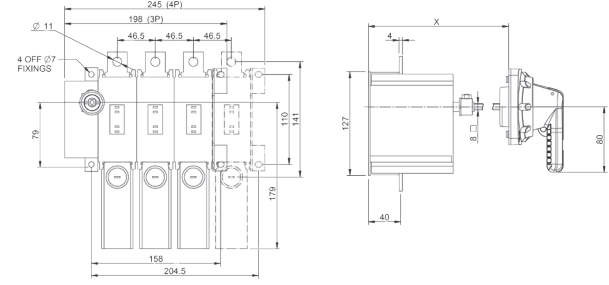

B3 Size (400A- 800A) - x3 = 163-257 | x4= 163-357

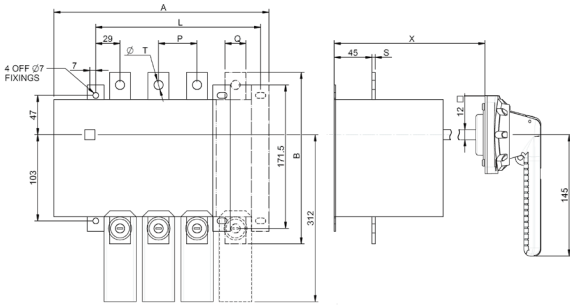

B4 Size (1000A-1250A)

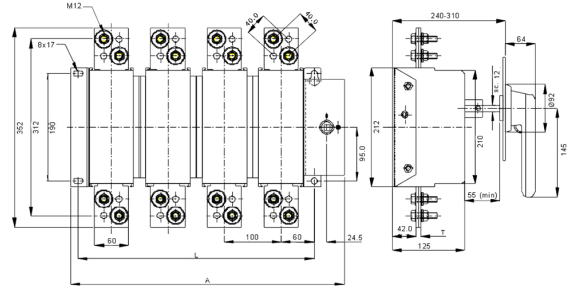

Rating	A		B	L		P	Q	S	T
	3P	4P		3P	4P				
400A	211	257	205	151	197	46	25	4	11
600A	244	306	223	183	245	62	40	5	13.5
800A	260	330	223	199	269	70	40	5	13.5

Standard Range

x3 = Min. & Max. (mm) with 200mm shaft extension

x4 = Min. & Max. (mm) with 400mm shaft extension

Rating	A		L		T
	3P	4P	3P	4P	
1000A	383	483	318	418	8
1250A	383	483	318	418	8

CHANGEOVER RANGE

Frame Size C1C- 63A & 100A

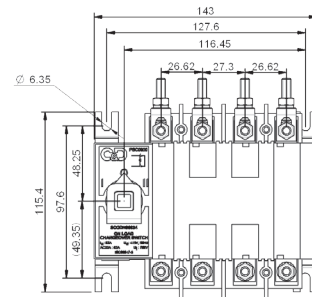
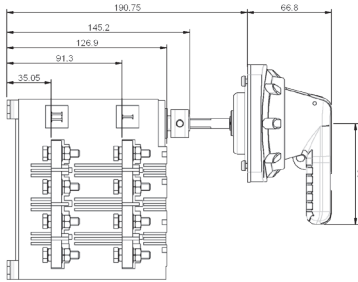

Frame Size C2C- 125A, 160A & 200A

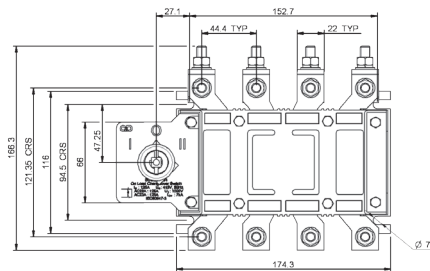
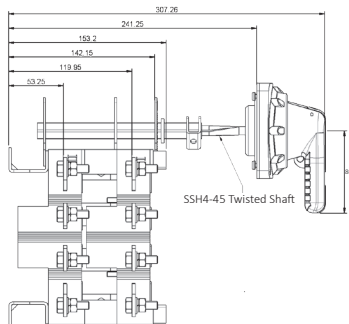

CHANGEOVER RANGE

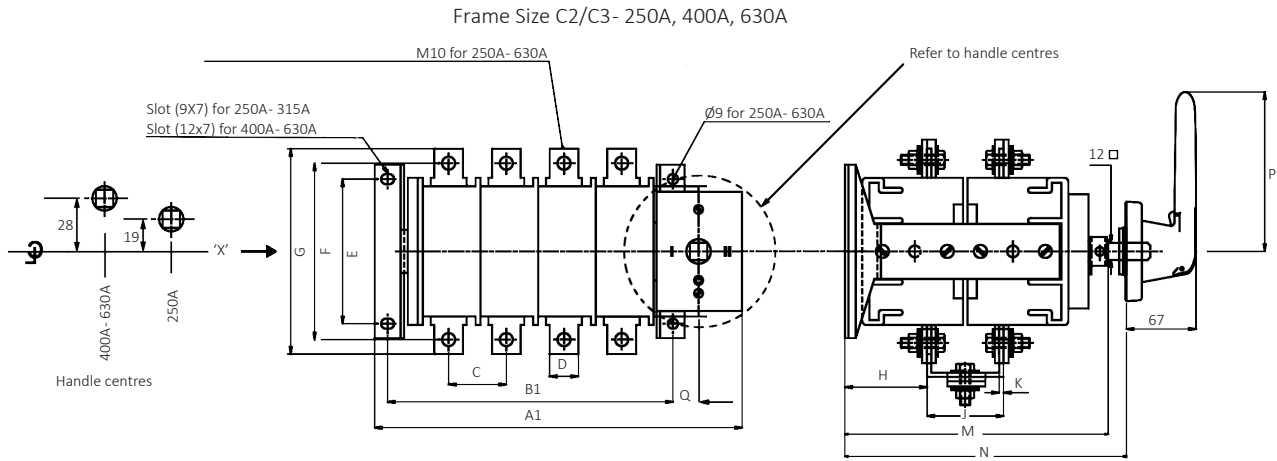

Rating	A1	B1	C	D	E	F	G	H	J	K	M	N	P	Q	Frame Size
250A	309.5	252	61	25	124	138	163	65.5	81	4.0	242	255-355	145	18	C2
400A	352	276	70	25	150	180	205	85	96	4.0	262	300-400	220	26	C3
630A	352	276	70	40	150	185	223	84	98	5.0	262	300-400	220	26	C3

FUSE COMBINATION RANGE

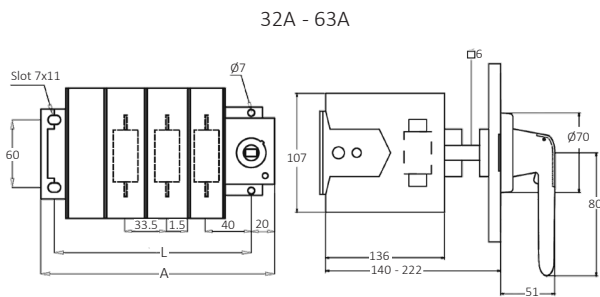

Format	A	L
3P+NL	168	138
3P+N	201	171

Frame Size D1

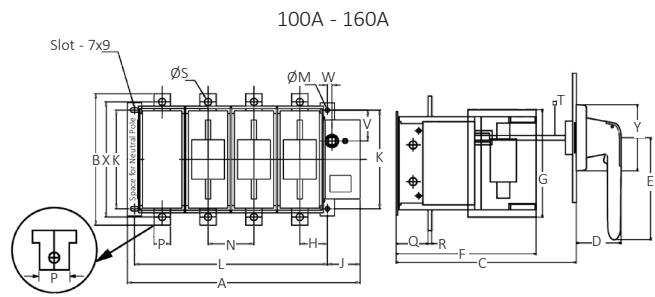

Rating	A		B	C	D	E	F	G	H	J	K
	3P+NL	3P+N									
100-125A	190	230	142	135-225	67	80	134	98	44.5	20	60
160A	212	260	142	135-225	67	80	134	98	44.5	20	60

Rating	L		M	N	P	Q	R	S	T	V	W	X	Y
	3P+NL	3P+N											
100-125A	160	198	7	40	20	40	2	9	6	30	0	122	93
160A	182	230	7	48	20	40	3	9	6	30	0	122	93

200A - 630A

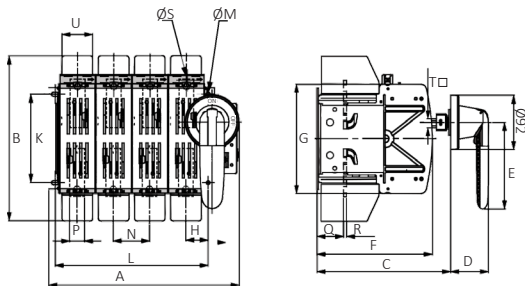

Rating	A		B	C	D	E	F	G	H	K	L		M	N	P	Q	R	S	T	U	Frame Size
	3P+NL	3P+N									3P+NL	3P+N									
200-250A	261	323	280	230-310	67	145	196	186	37	150	198	260	7	62	25	45	5	11	12	52	D4
315-400A	285	355	280	230-310	67	145	196	186	37	150	222	292	7	70	25	45	5	11	12	52	D5
630A	360	440	444	245-305	67	145	231	250	60	190	340	440	9	80	40	40	6	13	12	61	D6

CONTROL STATIONS

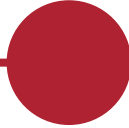

Craig & Derricott have been at the forefront of electrical control gear design and manufacture for 100 Years. The i-push range has been designed and developed to incorporate safety, functionality and ease of installation incorporating suggestions from re-sellers and end-users. The 'i-push' range contains many unique features:-

- Heavy (HD) & Normal Duty (ND) actuators
- Pushbutton position indicators
- Security fixing lids
- Protective guards
- Ingress protection
- Flap covers
- Safety contact
- Bespoke assemblies

All of the ranges are covered by one or more of the following international approvals:-

Germany



Canada



Netherlands



ENEC



Norway



Finland



UL



Denmark



Sweden



Det Norske Veritas



USA



China



Europe



EMERGENCY STOP CONTROL STATIONS

Emergency Stop stations are designed and installed primarily to provide machine operators with a means of shutting down in the event of a dangerous occurrence taking place.

Electrical machines often require Emergency Stops which are required to meet specific requirements and International standards (IEC/EN60204, IEC 60947-5-1, IEC 60947-5-5). These standards were applied to the design, testing and installation of such devices offer by Craig & Derricott.











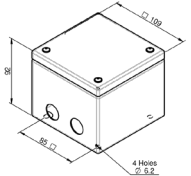

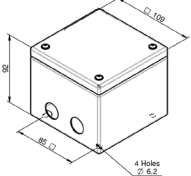

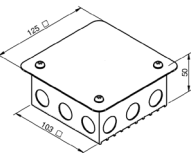

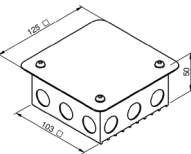
The following pages contain the following options:-

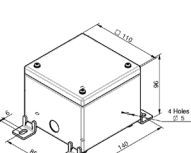
- Enclosure formats - PA / PC Plastic, Glass Filled Polyester, Die-Cast Aluminium, Stainless Steel, Sheet Steel & Flush Mounting.
- 'Reset' Methods - Twist-To-Reset, Pull-To-Reset & Key Reset
- Protection Devices - Raised Shroud & Flap Cover
- Actuators - Heavy (HD) & Normal Duty (ND)

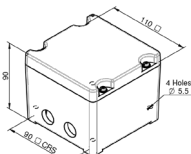
Emergency Stop Control Stations				
Image	Cat. No.	Description		Dimensions
	EMSL/TNS/PS/NC	Actuator Legend Contacts Enclosure Material IP Rating Entries Fixings	Emergency Stop, Twist-To-Reset None 1N/C (EMSL Base Mount) PC/PA IP66, IP67 & IP69K 2 x M20/M25/M16 4 x M4	ND
	EMSL/T/PS/NC	Actuator Legend Contacts Enclosure Material IP Rating Entries Fixings	Emergency Stop Twist-To-Reset Emergency Stop Circular Yellow 1N/C (EMSL Base Mount) PC/PA IP66, IP67 & IP69K 2 x M20/M25/M16 4 x M4	ND
	EMSL/K/PS/NC	Actuator Legend Contacts Enclosure Material IP Rating Entries Fixings	Emergency Stop Key Reset (2 Keys) Emergency Stop Circular Yellow 1N/C (EMSL Base Mount) PC/PA IP66, IP67 & IP69K 2 x M20/M25/M16 4 x M4	ND
	EMSL/TS/P/NC	Actuator Legend Guard Contacts Enclosure Material IP Rating Entries Fixings	Emergency Stop Twist-To-Reset None Raised Shroud 1N/C (EMSL Lid Mount) PC IP65 Plain Sides 2 x M4	ND
	EMSL/KS/P/NC	Actuator Legend Guard Contacts Enclosure Material IP Rating Entries Fixings	Emergency Stop Key Reset. (2 Keys) None Raised Shroud 1N/C (EMSL Lid Mount) PC IP65 Plain Sides 2 x M4	ND
	EMSL/TS/MG/NC	Actuator Legend Guard Contacts Enclosure Material IP Rating Entries Fixings	Emergency Stop Twist-To-Reset None Raised Shroud 1N/C (EMSL Lid Mount) Die-Cast Aluminium IP65 2 x M20 4 x M5	ND
	EMSL/KS/MG/NC	Actuator Legend Guard Contacts Enclosure Material IP Rating Entries Fixings	Emergency Stop Key Reset (2 Keys) None Raised Shroud 1N/C (EMSL Lid Mount) Die-Cast Aluminium IP65 2 x M20 4 x M5	ND

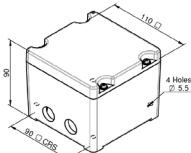

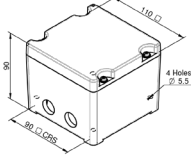

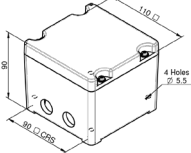





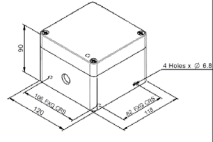

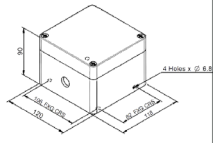
EMERGENCY STOP CONTROL STATIONS

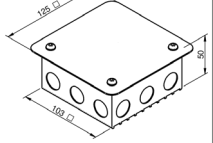
*EMSL/T/SS/NC69 is sealed to withstand the forces associated with pressure washers. Tested to withstand a hose delivering water at a pressure between 80-100 bar at a temperature of 80°C. The combination of a Stainless Steel enclosure and sealing to IP69K make these items ideally suited to environments where strict hygiene cleaning routines are enforced. Supplied with external fixing feet for vertical or horizontal mounting.

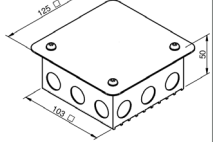
Emergency Stop Control Stations				
Image	Cat. No.	Description		Dimensions
	EMSL/T/SS/NC	Actuator Legend Contacts Enclosure Material IP Rating Entries Fixings	Emergency Stop, Twist-To-Reset Emergency Stop Circular Yellow 1N/C (EMSL Lid Mount) Stainless Steel IP65 2 x M20 4 x M6	ND 
	EMSL/K/SS/NC	Actuator Legend Contacts Enclosure Material IP Rating Entries Fixings	Emergency Stop Key Reset (2 Keys) Emergency Stop Circular Yellow 1N/C (EMSL Lid Mount) Stainless Steel IP65 2 x M20 4 x M6	ND 
	EMSL/T/F/NC	Actuator Legend Contacts Enclosure Material IP Rating Entries Fixings	Emergency Stop Twist-To-Reset Emergency Stop Circular Yellow 1N/C (EMSL Lid Mount) Stainless Steel IP65 9 x M20 knock-outs 4 x M5	ND 
	EMSL/K/F/NC	Actuator Legend Contacts Enclosure Material IP Rating Entries Fixings	Emergency Stop Key Reset (2 Keys) Emergency Stop Circular Yellow 1N/C (EMSL Lid Mount) Stainless Steel IP65 9 x M20 knock-outs 4 x M5	ND 
	EMSL/T/SS/NC69*	Actuator Legend Contacts Enclosure Material IP Rating Entries Fixings	Emergency Stop, Twist-To-Reset Emergency Stop circular Yellow 1N/C + safety contact (EMSL Lid Mount) Stainless Steel IP69K 1 x M20 4 x M6	ND 
	EMSH/P/MG/CO	Actuator Legend Contacts Enclosure Material IP Rating Entries Fixings	Emergency Stop Mushroom Pull-To-Reset Emergency Stop circular Yellow 1N/C+1N/O (MT-16A) Die-Cast Aluminium IP65 2 x M20 4 x M5	HD 
	EMSH/T/MG/CO	Actuator Legend Contacts Enclosure Material IP Rating Entries Fixings	Emergency Stop Mushroom Twist-To-Reset Emergency Stop circular Yellow 1N/C+1N/O (MT-16A) Die-Cast Aluminium IP65 2 x M20 4 x M5	HD 
	EMSH/K/MG/CO	Actuator Legend Contacts Enclosure Material IP Rating Entries Fixings	Emergency Stop Mushroom Key Reset (2 Keys) Emergency Stop circular Yellow 1N/C+1N/O (MT-16A) Die-Cast Aluminium IP65 2 x M20 4 x M5	HD 
	EMSH/P/F1/MG/CO	Actuator Legend Guard Contacts Enclosure Material IP Rating Entries Fixings	Emergency Stop Mushroom Pull-To-Reset Emergency Stop printed flap cover Padlocking flap cover 1N/C+1N/O (MT-16A) Die-Cast Aluminium IP65 2 x M20 4 x M5	HD 

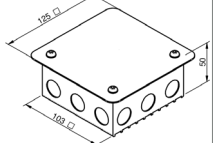
EMERGENCY STOP CONTROL STATIONS

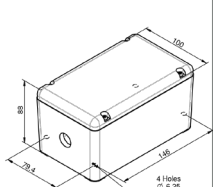
*As supplied there is an IP65 seal between the pushbutton and the face plate. To maintain this seal when installing the complete assembly the onus is upon the installer to use a continuous bead of flexible sealant to provide an effective seal between the rear of the face plate and what may be an uneven mounting surface.

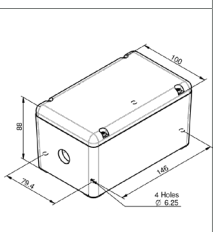
Emergency Stop Control Stations				
Image	Cat. No.	Description		Dimensions
	EMSH/T/GP/CO	Actuator Legend Contacts Enclosure Material IP Rating Entries Fixings	Emergency Stop Mushroom Twist-To-Reset HD Emergency Stop circular Yellow 1N/C+1N/O (MT-16A) Glass Filled Reinforced Polyester IP65* 1 x M20 4 x M5	
	EMSH/K/GP/CO	Actuator Legend Contacts Enclosure Material IP Rating Entries Fixings	Emergency Stop Mushroom Key Reset (2 Keys) HD Emergency Stop circular Yellow 1N/C+1N/O (MT-16A) Glass Filled Reinforced Polyester IP65* 1 x M20 4 x M5	
	EMSH/T/F/CO	Actuator Legend Contacts Enclosure Material IP Rating Entries Fixings	Emergency Stop Mushroom Twist-To-Reset HD Emergency Stop circular Yellow 1N/C+1N/O (MT-16A) Stainless Steel IP65* 9 x M20 Knock-outs 4 x M5	
	EMSH/K/F/CO	Actuator Legend Contacts Enclosure Material IP Rating Entries Fixings	Emergency Stop Mushroom Key Reset (2 Keys) HD Emergency Stop circular Yellow 1N/C+1N/O (MT-16A) Stainless Steel IP65* 9 x M20 Knock-outs 4 x M5	
	EMSH/P/F1/F/CO	Actuator Legend Guard Contacts Enclosure Material IP Rating Entries Fixings	Emergency Stop Mushroom Pull-To-Reset HD Padlocking flap cover Emergency Stop pad printed flap cover 1N/C+1N/O (MT-16A) Stainless Steel IP65* 9 x M20 Knock-outs 4 x M5	
	SSTH/GS/P/F1/MG/CO	Actuator Legend Guard Contacts Enclosure Material IP Rating Entries Fixings	a/ Start, momentary b/ Emergency Stop, Pull-To-Reset HD a/ Start b/ Emergency Stop Printed flap cover Padlocking flap cover 1N/C+1N/O (MT-16A) Die-Cast Aluminium IP65 1 x M20 4 x M5	
	ESSH/GS/P/MG/CO	Actuator Legend Contacts Enclosure Material IP Rating Entries Fixings	a/ Start, momentary b/ Emergency Stop, mushroom Pull-To-Reset HD a/ Start b/ Emergency Stop Circular Yellow 1N/C+1N/O (MT-16A) Die-Cast Aluminium IP65 1 x M20 4 x M5	



EMERGENCY POWER OFF CONTROL STATIONS

'Emergency Power Off' or 'EPO' control stations can be used where the safety requirements associated with Emergency Stops are not required.

Typical uses would include:-

- Computer suites
- School workshops
- Water treatment plants
- Service and maintenance



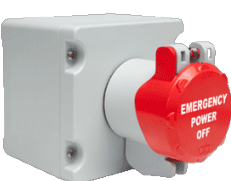
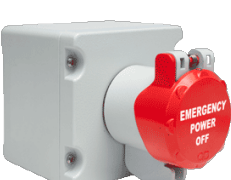







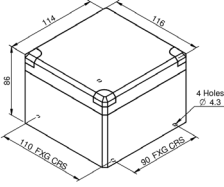

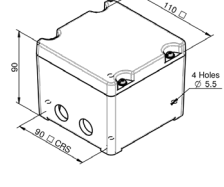
All items are housed in robust Die-Cast Aluminium enclosures fitted with flap covers to prevent accidental operation.

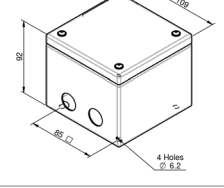
Emergency Power Off Control Stations			
Image	Cat. No.	Description	Dimensions
	EPOL/T/F5/MG/NC	Actuator Legend Guard Contacts Enclosure Material IP Rating Entries Fixings	Twist-To-Reset Emergency Power Off Printed Flap Cover Flap Cover Non-Locking 1N/C (EMSL Lid Mount) Die-Cast Aluminium IP65 2 x M20 4 x M5
	EPOL/K/F5/MG/NC	Actuator Legend Guard Contacts Enclosure Material IP Rating Entries Fixings	Key-To-Reset (2 Keys) Emergency Power Off Printed Flap Cover Flap cover non-locking 1N/C (EMSL Lid Mount) Die-Cast Aluminium IP65 2 x M20 4 x M5
	EPOH/M/F5/MG/CO	Actuator Legend Guard Contacts Enclosure Material IP Rating Entries Fixings	Mushroom Momentary Action Emergency Power Off printed flap cover Flap cover non-locking 1N/C+1N/O (MT-16A) Die-Cast Aluminium IP65 2 x M20 4 x M5
	EPOH/P/F5/MG/CO	Actuator Legend Guard Contacts Enclosure Material IP Rating Entries Fixings	Mushroom, Pull-To-Reset Emergency Power Off printed flap cover Flap cover non-locking 1N/C+1N/O (MT-16A) Die-Cast Aluminium IP65 2 x M20 4 x M5
	EPOH/K/F5/MG/CO	Actuator Legend Guard Contacts Enclosure Material IP Rating Entries Fixings	Mushroom Key Reset (2 Keys) Emergency Power Off printed flap cover Flap cover non-locking 1N/C+1N/O (MT-16A) Die-Cast Aluminium IP65 2 x M20 4 x M5

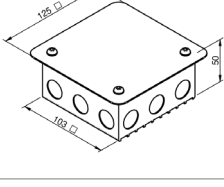
STOP, START AND STOP/START CONTROL STATIONS

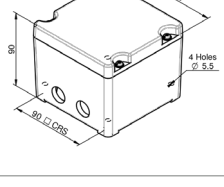
Individual 'Stop', 'Start' and 'Stop/Start' stations have been designed for use in many applications.

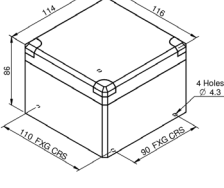

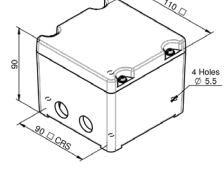







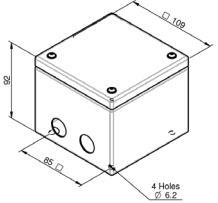

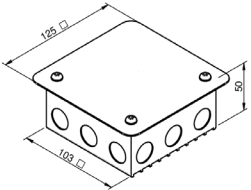
The range includes alternatives for both surface and flush mounting with options of flap covers which add an extra degree of security against inadvertent operation.

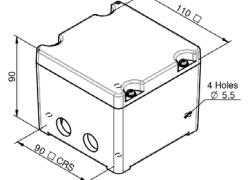
Stop Control Stations					
Image	Cat. No.	Description			Dimensions
	STOL/RS/P/NC	Actuator Legend Contacts Enclosure Material IP Rating Entries Fixings	Full guard, Momentary Stop 0 1N/C (EMSL Lid Mount) PC IP65 Plain Sides 2 x M4	ND	
	STOL/RS/MG/NC	Actuator Legend Contacts Enclosure Material IP Rating Entries Fixings	Full guard, Momentary Stop 0 1N/C (EMSL Lid Mount) Die-Cast Aluminium IP65 2 x M20 4 x M5	ND	
	STOL/RS/SS/NC	Actuator Legend Contacts Enclosure Material IP Rating Entries Fixings	Full guard, Momentary Stop 0 1N/C (EMSL Lid Mount) Stainless Steel IP65 2 x M20 4 x M6	ND	
	STOL/RS/F/NC	Actuator Legend Contacts Enclosure Material IP Rating Entries Fixings	Full guard, Momentary 0 1N/C (EMSL Lid Mount) Stainless Steel IP65 9 x M20 Knock-outs 4 x M5	ND	
	STOH/P/F3/MG/CO	Actuator Legend Guard Contacts Enclosure Material IP Rating Entries Fixings	Mushroom Pull-To-Reset Stop printed flap cover Flap cover non-locking 1N/C+1N/O (MT-16A) Die-Cast Aluminium IP65 2 x M20 4 x M5	HD	
Start Control Stations					
	STAL/GS/P/NO	Actuator Legend Contacts Enclosure Material IP Rating Entries Fixings	Full guard, Momentary Start I 1N/O (EMSL Lid Mount) PC IP65 Plain Sides 2 x M4	ND	
	STAL/GS/MG/NO	Actuator Legend Contacts Enclosure Material IP Rating Entries Fixings	Full guard, Momentary Start I 1N/O (EMSL Lid Mount) Die-Cast Aluminium IP65 2 x M20 4 x M5	ND	

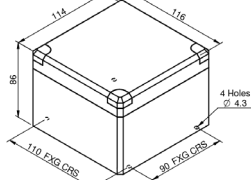
STOP, START AND STOP/START CONTROL STATIONS

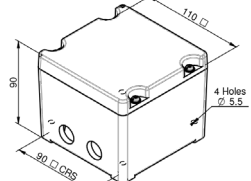
Individual 'Stop', 'Start' and 'Stop/Start' stations have been designed for use in many applications.

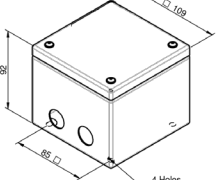
The range includes alternatives for both surface and flush mounting with options of flap covers which add an extra degree of security against inadvertent operation.

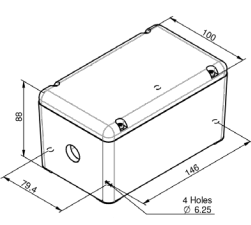
Start Control Stations					
Image	Cat. No.	Description			Dimensions
	STAL/GS/SS/NO	Actuator Legend Contacts Enclosure Material IP Rating Entries Fixings	Full guard, Momentary Start I 1N/O (EMSL Lid Mount) Stainless Steel IP65 2 x M20 4 x M6	ND	
	STAL/GS/F/NO	Actuator Legend Contacts Enclosure Material IP Rating Entries Fixings	Full guard, Momentary Start I 1N/O (EMSL Lid Mount) Stainless Steel IP65 9 x M20 Knock-outs 4 x M5	ND	
	STAH/GS/MG/CO	Actuator Legend Contacts Enclosure Material IP Rating Entries Fixings	Full guard, Momentary Start Start 1N/O (MT-16A) Die-Cast Aluminium IP65 2 x M20 4 x M5	HD	
Stop / Start Control Stations					
	SSTL/GS/RS/P/NO	Actuator Legend Contacts Enclosure Material IP Rating Entries Fixings	Full guard, Momentary Start / Stop O & I I - 1N/O (EMSL Lid Mount) O - 1N/C (EMSL Lid Mount) PC IP65 Plain Sides 2 x M4	ND	
	SSTL/GS/RS/MG/NO	Actuator Legend Contacts Enclosure Material IP Rating Entries Fixings	Full guard, Momentary Start / Stop O & I I - 1N/O (EMSL Lid Mount) O - 1N/C (EMSL Lid Mount) Die-Cast Aluminium IP65 2 x M20 4 x M5	ND	
	SSTL/GS/RS/SS/NO	Actuator Legend Contacts Enclosure Material IP Rating Entries Fixings	Full guard, Momentary Start O & I I - 1N/O (EMSL Lid Mount) O - 1N/C (EMSL Lid Mount) Stainless Steel IP65 2 x M20 4 x M6	ND	
	SSTH/GS/RS/MG/CO	Actuator Legend Contacts Enclosure Material IP Rating Entries Fixings	Full guard, Momentary Start Start & Stop Start- 1N/O (MT-16A) Stop- 1N/C (MT-16A) Die-Cast Aluminium IP65 1 x M20 4 x M5	HD	

EXPLOSION PROOF CONTROL STATIONS

In the UK from July 2006 the onus was placed upon companies to ensure that all equipment within their organisations is suitable for the environment in which it is being used. This was aimed primarily at areas where there may be a possibility of a combustible atmosphere being present, even for short periods e.g. less than 10 hours/year.









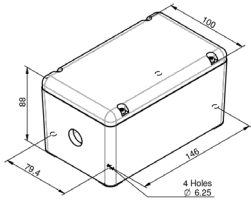

People normally associate such atmospheres as being gases, mists or vapours. However there are many industries where a non-conductive dust mixed with air in the right proportion can become potentially explosive. It is these areas where the Craig & Derricott ATEX Group II (Zone 22 equipment) can be used to help you comply with Health & Safety regulations. All listed items shown here have been certified to the appropriate international standards for explosive atmospheres.

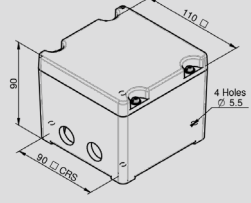
Certification data:

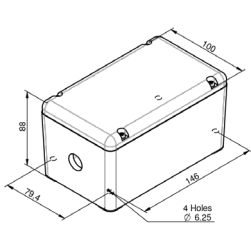
Ex II 3D, EX tD A22 IP65 T85°C

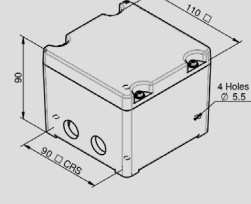

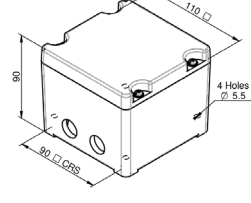

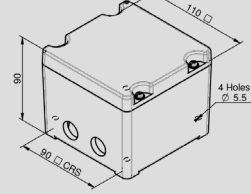





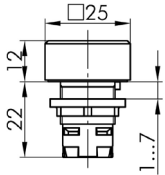
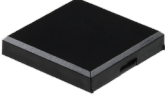
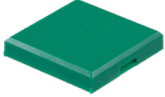

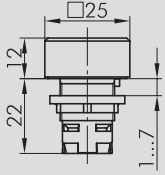
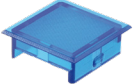
Complies in part or full with:

BS EN 50014, BS EN 50281-1-1, BS EN 60529, BS EN 60947-3, BS EN 60204-1

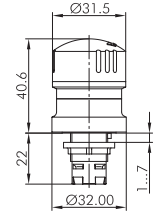
Explosion Proof Control Stations				
Image	Cat. No.	Description		Dimensions
	SSTH/GS/RS/MG/COZ	Actuator Legend Contacts	Full guard, Momentary start / stop HD Start & Stop Start - 1N/O (MT-16A) Stop - 1N/C (MT-16A)	
	EMSH/T/MG/COZ	Actuator Legend Contacts	Mushroom, Twist-To-Reset HD Emergency Stop circular Yellow 1N/C+1N/O (MT-16A)	
	ESSH/GS/P/MG/COZ	Actuator Legend Contacts	a/ Start, Momentary HD b/ Emergency stop, Pull-To-Reset a/ Start b/ Circular Yellow Start - 1N/O (MT-16A) Emergency Stop - 1N/C (MT-16A)	
	EMSH/P/MG/COZ	Actuator Legend Contacts	Mushroom, Pull-To-Reset HD Emergency Stop circular Yellow 1N/C+1N/O (MT-16A)	
	EMSH/P/F1/MG/COZ	Actuator Legend Guard Contacts	Emergency stop, Pull-To-Reset HD Emergency Stop Printed Flap Cover Padlocking Flap Cover 1N/C+1N/O (MT-16A)	
	EMSH/K/MG/COZ	Actuator Legend Contacts	Mushroom, Key Reset (2 Keys) HD Emergency Stop Circular Yellow 1N/C+1N/O (MT-16A)	

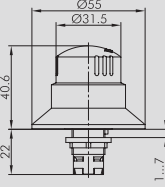
16 SERIES

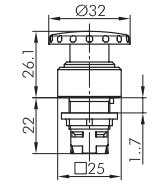

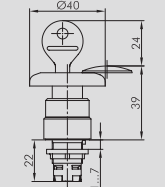







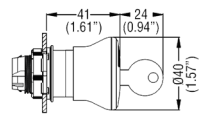

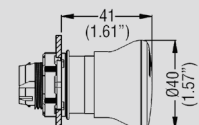
The 16 Series offers the user components with an attractive appearance and a small panel footprint. The square format allows simple alignment and the facility to butt components together to form very a compact multi-unit assembly. Although small in size, they are designed to withstand the rigours of normal industrial applications.

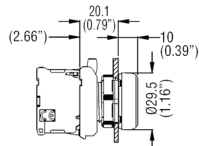
Image	Cat. No.	Description	Dims
	QXT QXTDG	Pushbutton Actuator 25mm x 25mm Momentary Action. Body Colour Black Charcoal (Contact block options AF, AT, AT2, ATL & ATL2) Requires flat colour cap & inscription plate	
	T25FG...	Flat Colour Caps Non Transparent - No Inscriptions WS - White, RT - Red, GN - Green, GB - Yellow, SW - Black, BL - Blue. (Add code letters to cat no e.g. T25FGRT)	
	T25F...	Flat Colour Caps Transparent- No Inscriptions WS - White, RT - Red, GN - Green, GB - Yellow, SW - Black, BL - Blue, KL - Clear (Add code letters to cat no e.g. T25FRT)	
	QXN QXNDG	Pilot Lamp 25mm x 25mm Colour Black Charcoal (Contact block options AL5) Requires Flat lens & Inscription Plate	
	KF25...	Pilot Lamp Lenses - Flat WS - Opal White, RT - Red, GN- Green, GB - Yellow, BL - Blue, KL - Clear (Add colour code to cat no e.g. KF25GB) For use with QXN..	
	BSQXU	Blank Inscription Plate	
	BSQX...	Printed Inscription Plate Hundreds of standard printed images and text available, Speak to our sales department for details.	
	BSQXB	Printed Inscription Plate Printed to customers own requirements. Suitable for QXT....	
	RXUV	Emergency Stop Actuator with Position Indicator Stayput Twist-To-Reset. Red Button, Yellow Surround and Green Position Indicator. (Contact block options AT & AT2) In accordance with EN 60068, EN ISO 13850, EN 60947-5-1 and EN 60947-5-5.	
	RXBUV	As the previous item but with anti-lock collar. Red actuator & Yellow body, Twist-To-Reset action. (Contact block options AT & AT2)	
	QXS QXSDG	Stop actuator 25mm x 25mm Red actuator, momentary action. Body Colour Black Charcoal (Contact block options AT & AT2)	
	QXVSCH QXVSCHDG	Emergency Stop actuator 25mm x 25mm Red actuator, stayput Key Reset action. Body Colour Black Charcoal (Contact block options AT & AT2) Replacement Key- ES3A	

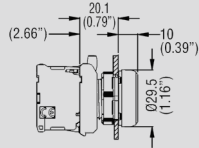
22 SERIES

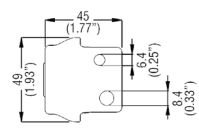
Wherever the design of a control panel requires robustness, long life and reliability, then the 22 Series components meet the need. As well as looking elegant in their own right, they are often used as replacement items where other, less able components, have failed.

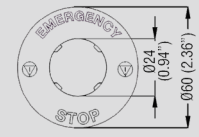
With a standard 22mm fixing, the range of actuators and contact block options lend themselves to a wide variety of applications- processing and manufacturing machines, shipbuilding, rail rolling stock, cranes & hoists, elevators and many other electromechanical applications.

Image	Cat. No.	Description	Dims
	22EMK/40	Emergency Stop Actuator with Position Indicator Stayput Key-To-Reset. Red button, Yellow surround and green position indicator.	
	22EMT/40	Emergency Stop Actuator with Position Indicator Stayput Twist-To-Reset. Red button, Yellow surround and green position indicator.	
	22PB/GN043	Ø22 Push Button Actuator- Green	
	22PB/RD041	Ø22 Push Button Actuator-Red	
	ACC/PLPS	Yellow Padlockable Shroud. Cannot be used with a legend plate.	
	ACC/ESP60	Yellow Emergency Stop Legend Plate. Cannot be used with a padlockable shroud.	
	MA3	Mounting Holder For 3 Contact Blocks For 22 series only.	





32 SERIES

The 32 Series has long been recognised as being the pinnacle of strength and reliability in control gear components. All actuator bodies and locking rings are produced in Aluminium, with a silver anodised finish. The range incorporates all of the options required in today's safety conscious world, and all of the various items bring with them the ultimate in reliability.

There are several options suitable for Emergency Stop use, and to match the quality of the tactile components, the '32 Series' includes contact blocks with a generous rating which meet the latest safety requirements.

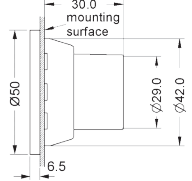
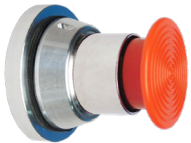
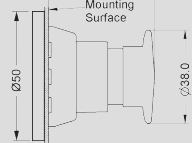
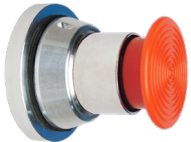
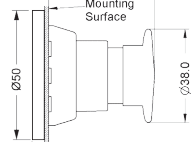
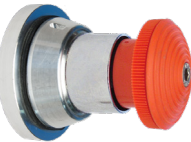
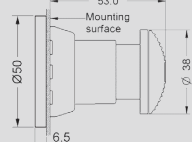

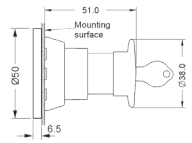

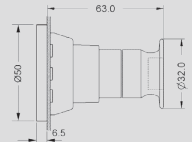



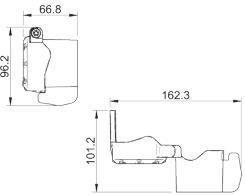

*Suitable for Emergency Stop use.

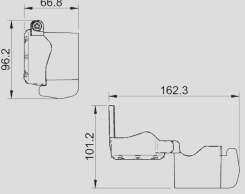
** 2 x DC800 series Keys are supplied with each actuator as standard. Differs are available to special order.

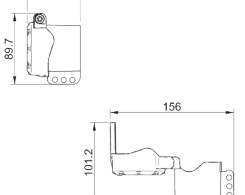
Image	Cat. No.	Description	Dims
	PR/SCH PG/SCH PY/SCH PZ/SCH PB/SCH PW/SCH	Full Guard Actuator- Momentary. Moulded Colour Cap: Red Green Yellow Blue Black White	
	PMR/SCH PMB/SCH PMG/SCH PMY/SCH PMZ/SCH	Mushroom Actuator Ø38- Momentary. Moulded Button. Actuator Colour: Red Black Green Yellow Blue	
	PMRH/SCH PMBH/SCH PMGH/SCH PMYH/SCH PMZH/SCH	Mushroom Actuator Ø38 - Stayput, Pull-To-Reset Moulded Button. Actuator Colour: Red* Black Green Yellow Blue	
	PMR-U59/SCH	Mushroom Actuator Ø38 - Stayput, Twist-To-Reset. Moulded Free To Turn Button With Rear Reset Ring. Actuator Colour: Red*	
	PMRA-U19 /SCH PMBA-U19 /SCH	Mushroom Actuator Ø38 - Stayput, Key Reset** Die-Cast Button. Actuator Colour: Red* Black	
	PMARH- U51/SCH	Mushroom actuator Ø32 - Stayput, Pull-To-Reset Die-Cast Button. Actuator Colour: Red* (Designed specifically to work beneath flap covers to allow access for resetting)	

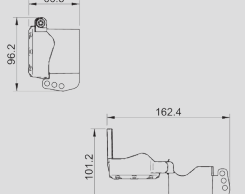

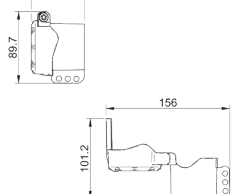

32 SERIES ACCESSORIES

The user can fit up to five 16A rated contact blocks on the back of an actuator, giving flexibility without rating constraints. The range incorporates many unique features and accessories, an example of which are the very popular Die-Cast flap covers. These are supplied in several variations to suit different levels of security and function. The 32 Series offers the user flexibility with strength.

Image	Dims	Description	Cat. No.
	U260-R	Non-lockable Die-Cast Aluminium Flap Cover. Grey Body With Red Flap. Used to prevent accidental operation of a pushbutton or similar devices. Spring loaded so the flap is kept closed. 4 off M3.5 fixings on Ø49 PCD	
	U270-R	Non-lockable Die-Cast Aluminium Flap Cover. Grey Body With Red Flap. Used to prevent accidental operation of a pushbutton or similar devices, cover is not spring loaded. 4 off M3.5 fixings on Ø49 PCD	
	U280-R	Padlockable Die-Cast Aluminium Flap Cover. Grey Body With Red Flap (Other colours available to special order). Used to prevent unauthorised access to the actuator. Holes in the flap cover body are available to place up to three padlocks which will lock the cover closed. The cover cannot be opened until the last padlock has been removed. 4 off M3.5 fixings on Ø49 PCD	
	U290-R	Padlockable Die-Cast Aluminium Flap Cover. Grey Body With Red Flap (Other colours available to special order). Used to prevent unauthorised Resetting of stayput actuators. The flap is depressed to actuate the unit with the padlock(s) in position. The actuator remains in the operated position until access is allowed by removal of the padlock(s). 4 off M3.5 fixings on Ø49 PCD	
	U310-R	Padlockable Die-Cast Aluminium Flap Cover. Grey body With Red Flap (Other colours available to special order). Used as a hold button. The cover is depressed to operate the pushbutton, and it is manually held down whilst the padlock(s) are inserted. The pushbutton remains depressed until the padlock(s) are removed. 4 off M3.5 fixings on Ø49 PCD	
	-0001 -0002 -0010 -0016 -0129	Flap Cover Engraving STOP EMERGENCY STOP EMERGENCY TRIP EMERGENCY POWER OFF PRESS FIRMLY FOR EMERGENCY STOP Example:- U290-R-001 Other engravings can be accommodated, please contact our sales to discuss your requirements.	

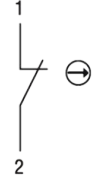

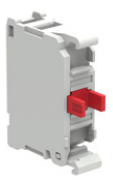
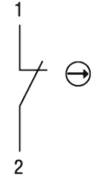
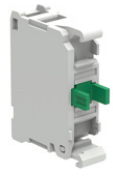

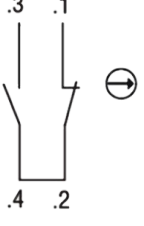
EMSL Series





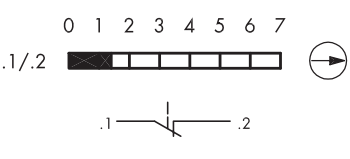

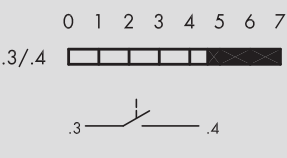

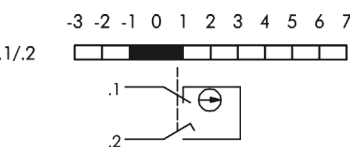





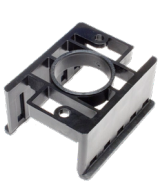



For use with the 22 Series Actuators. A clip-in module which can be supplied in N/O and N/C format. Each contact block has screw termination and designed for Direct snap-on mounting to control station base. Maximum tightening torque for screw terminals: 1Nm.

Image	Series	Cat. No.	Description	Contact Details
	EMSL	EMSL/NC	Base Mounted Normally Closed Contact Block <ul style="list-style-type: none"> Screw termination Direct snap-on mounting to control station base Maximum tightening torque for screw terminals: 1Nm 	
	EMSL	EMSL/NO	Base Mounted Normally Open Contact Block <ul style="list-style-type: none"> Screw termination Direct snap-on mounting to control station base Maximum tightening torque for screw terminals: 1Nm 	
	EMSL	CB1NC	Lid Mounted Normally Closed Contact Block <ul style="list-style-type: none"> Screw termination Direct snap-on mounting to control station actuator Maximum tightening torque for screw terminals: 1Nm 	
	EMSL	CB1NO	Lid Mounted Normally Open Contact Block <ul style="list-style-type: none"> Screw termination Direct snap-on mounting to control station actuator Maximum tightening torque for screw terminals: 1Nm 	
	EMSL	CB01NCSM	Lid mounted normally closed safety contact block available for Emergency Stop control stations. When inserted the Red plunger will be operated by the pushbutton actuator, the green plunger will retain a N/C contact when the block is pushed fully home and clicked in-place. Should for any reason the block become loose, the contact under the green plunger will open and initiate a stop function. <ul style="list-style-type: none"> Screw termination Direct snap-on mounting to control station actuator Maximum tightening torque for screw terminals: 1Nm 	

MT Series

For use with the 32 Series Actuators. The 32 Series components share common modules. All items are tested and approved to the latest international standards and offer excellent performance with extended life.

Image	Series	Cat. No.	Description	Contact Details
	MT	MTO	Modular Contact Block, Momentary. 1 N/C	
	MT	MTI	Modular Contact Block, Momentary. 1 N/O	
	MT	MTOSFE	Modular Contact Block, Momentary, for Emergency Stop Actuators. 1 N/C safety contact switching off in an emergency and 1 N/C series contact that opens should the contact block become detached from the actuator. Not compatible with 32 Series Actuators.	

MT Series				
For use with the 32 Series Actuators. The 32 Series components share common modules. All items are tested and approved to the latest international standards and offer excellent performance with extended life.				
Image	Series	Cat. No.	Description	Contact Details
	MT	ML	Lamp Module BA9s Max. 250V 2W	X1 —  — X2
	MT	MFL	Latching Module- BA9s When used as the centre element in the module holder, it provides a maintained unit with the adjacent momentary type modules. Max. 250V 2W	X1 —  — X2
	MT	MHR-5C	Holder for 5 Modules. Screw Fitting On Actuator. For '32 Series' only Not applicable with MTOSFE.	
ET Series				
The 'ETR' block provides N/O + N/C contacts in one assembly.				
Image	Series	Cat. No.	Description	Contact Details
	ET	ETR	Contact block, momentary action 1 N/O + 1 N/C	<p>0 1 2 3 4 5 6</p> <p>12/11  </p> <p>24/23 </p> <p>12 —  — 11</p> <p>24 —  — 23</p>
S1 Series				
The S1 contact block is designed to be stacked in pairs side-by-side and then back-To-back making a total of four changeover blocks on one Heavy Duty actuator. Three or four blocks will require extended fixing screws (U42)				
Image	Series	Cat. No.	Description	Contact Details
	S1	S1	Contact block, momentary action C/O	<p>NC —  — NC</p> <p>NO —  — NO</p>
	S1	U42	Assembly screw kit to enable 3 or 4 'S1' contacts to be mounted on a single Heavy Duty actuator.	
Monobloc Series				
The Monobloc assembly is designed for use in very restricted space. The contacts are assembled in the base of the actuator and cannot be supplied separately. To replace the contacts will require a new complete actuator.				
Image	Series	Cat. No.	Description	Contact Details
	Mono Bloc	FRVKOO	Contact block, momentary action 2 N/C	<p>12 —  — 11 </p> <p>22 —  — 21 </p>

Other contact blocks and accessories are available on request, please contact our sales team for further details.

TECHNICAL SPECIFICATION

Electrical Ratings- BS EN 60947-5-1.

EMSL Series										
Application										
IEC/EN Operational characteristics (AC15)	V	12	24	48	120	240	400	480	500	600
	A	6	6	6	6	6	3	1.5	1.4	1.2
IEC/EN Operational characteristics (DC13)	V	12	24	48	125	250	-	440	500	600
	A	3	3	1.5	0.55	0.27	-	0.15	0.13	0.1
Short circuit protection fuse (max calibre)	10A gG/SC									
Contact resistance	≤20m Ω									
Terminals	Clamp screw with washer Faston 1x 6.35mm (0.25") 2x 2.8mm (0.11")									
Maximum conductor cross section for screw terminals	1 or 2 2.5mm ² or AWG14 cables									
Mechanical & electrical endurance: Operating force	≤0.5kg / 1.1lb (auxiliary contacts)									
Mechanical & electrical endurance: Electrical life	1,000,000 cycles / 600,000 cycles									
Compliant with standard	IEC/EN 60947-1, IEC/EN 60947-5-1, UL508, CSA C22.2 n° 14.									

MT Series											
Application											
Storage Temperature	-50°C up to +85°C										
Operating Temperature	-30°C up to +85°C							For non-illuminated items			
	-30°C up to +55°C							Using incandescent lamps			
	-30°C up to +65°C							Using LED's			
Operating Travel	6mm										
Connections	Screw connections for 2 x 2.5mm ² , IP2X.										
Lamp Type/Socket	Incandescent lamps, LED's / BA9s										
Contact Material	Silver-nickel alloy (Ag/Ni). Gold Plated Version available upon request.										
Mechanical Life	1 million operations										
Electrical Life	1 million cycles at rated load										
Min. Current / Voltage	1 mA / 5V (Under laboratory conditions)										
Contact Resistance (New State)	< 20mΩ										
Bounce Time	< 10 mS										
Positive Opening N/C Contact	To EN 60947-5-1 appendix K										
Continuous thermal current (I _{th})	16A										
Rated Insulation Voltage (U _i)	600V										
Utilisation Category	A.C.	AC15 A600									
	D.C.	DC13 Q600									
Rated Operational Voltage (U _e)	A.C.	250V/440V									
	D.C.	440V / 250V /125V / 60V / 24V									
Rated Operational Current (I _e)	A.C.	3A/1.6A									
	D.C.	0.12A / 0.2A / 0.4A / 1A / 2A									
Breaking Capacity (I _e)	A.C.	10									
	D.C.	1.1									
Lamp Socket	BA9s										
Lamp Voltage	Max. 250V (CSA max. 125V)										
Lamp Output	Max. 2W										
Definition	X1.. anode, X2.. cathode.										

ET, S1 & Monobloc Series											
Series	Current	Utilisation Category	Rated Insulation Voltage (U _i)	Rated Operational Voltage (U _e) / Current (I _e)						Breaking Capacity	Continuous thermal current (I _{th})
ET	a.c.	AC15	400V	V	-	-	-	250	400	10Ie	10A
				A	-	-	-	5	3		
	d.c.	DC13	400V	V	24	60	125	250	400	1.1Ie	10A
				A	2	1	0.4	0.2	0.12		
S1	a.c.	AC15	660V	V	-	-	-	-	400	-	10A
				A	-	-	-	-	5		
Monobloc	a.c.	AC15 B300	250V	V	-	-	120	240	-	-	10A
				A	-	-	5	5	-		

ENCLOSED SAFETY SWITCHES

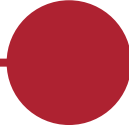

Enclosed safety (grabwire) switches are the equipment of choice to provide safety protection over long distances. Prior to the development of Grabwire switches, machinery such as conveyors had to be fitted with a number of separate Emergency Stops. Positioning the 'Stops' such that at least one could be reached from any point, was often difficult to fulfil.

Conveyors are the obvious application for such devices, but with the ability to take the protection wire around bends, and provide safety cover over both horizontal and vertical runs, the system lends itself to many different applications.

Reference standards:-

BS EN ISO 12100-1:2003 Pts. 1 & 2 | BS EN 418 | BS EN 60947-5-1 | BS EN 60529 | BS EN 60947-5-5 | BS EN 60204-1 | PD 5304.



GW RANGE

The 'GW' range, is a tensioned wire system which is designed to cover small to medium sized runs. (Up to 100m max. between pairs). A Grabwire switch assembly gives a continuous and uninterrupted safety provision over long distances.

Prior to the development of Grabwire switches, machinery such as conveyors had to be fitted with a number of separate Emergency Stops. Positioning the 'Stops' such that at least one could be reached from any point, was often difficult to fulfil. Conveyors are the obvious application for such devices, but with the ability to take the protection wire around bends, and provide safety cover over both horizontal and vertical runs, the system lends itself to many different applications.

The minimum requirements in this situation would be a Grabwire Switch at one end and an Anchor Box at the other.

The effective installation involves the fitting of Grabwire switches at both ends of the 'Pull wire'. However, this does involve electrical cabling up to, and between, the switching units. The use of a non electrical 'Anchor Box' at one end removes the need to cable between the end assemblies.

The 'Anchor Box' effectively houses a long spring, which is compressed when the 'Pull wire' is activated. At a fixed point during the compression, a latch is operated which locks the spring in the compressed or shortened state. When the 'Pull wire' is released, it will be in a 'slack' condition, and the switching unit at the other end of the 'Pull wire' senses the 'slack' condition and activates the 'Stop' signal. Although the 'Anchor Box' contains no electrical contacts, the latch needs manual Resetting to restore the system.

Apart from the Grabwire switch, the only other item required in a simple set-up, is the connection kit. In the kit you will find all the parts necessary to install the system.







				
Cat. No.	GWN1	GWN2	GWN2/SS	GWDE
Description	Universal single ended	Universal single ended	Universal single ended	Universal double ended
Max. span between pairs (L) (or between switch & anchor box)	50m	100m	100m	2 x 100m
Encl. Material	Die-Cast Aluminium (LM24)	Die-Cast Aluminium (LM24)	Stainless Steel 1.6 mm Grade 316	Sheet Steel 1.6 mm
Finish	Textured Powder Coat RAL 3020	Textured Powder Coat RAL 3020	Polished	Textured Powder Coat RAL 3020
Ingress Protection	IP65	IP65	IP65	IP65
Rope Tensioner	Included	Included	Included	Included
Earthing	M4 Internal & External	M5 Internal & External	M5 Internal & External	M5 Internal & External
Electrical Contacts	2 N/C (Safety) + 1 N/O	2 N/C (Safety) + 2 N/O	2 N/C (Safety) + 2 N/O	2 x {2 N/C (Safety) + 2 N/O}
Electrical Rating:- I_{th} / U_i	10A/415V	10A/415V	16A/600V	16A/600V
AC21/22/23A to BS EN 60947-3	-	-	16A at 415V	16A at 415V
AC15 to BS EN 60947-5-1	5A at 415V	5A at 415V	5A at 415V	5A at 415V
Optional Indicator Lamp	✓	✓	-	-
Setting-up indicator	✓	✓	✓	✓
Hand Reset knob	✓	✓	✓	✓
Universal (LH or RH) mounting	✓	✓	✓	✓

Image	Cat. No.	Description
	Basic - GK00* Up to 5m - GK5 Up to 10m - GK10 Up to 20m - GK20 Up to 50m - GK50 Up to 75m - GK75 Up to 100m - GK100	Each connection kit includes:- <ul style="list-style-type: none"> Multi strand steel catenary cable with red PVC covering* Stainless Steel eyebolt supports. Sufficient to support the cable at 2M intervals. Supplied complete with two fixing nuts* 2 x Stainless Steel thimbles 2 x Stainless Steel 'D' shackles 2 x Stainless Steel clamps

INSTALLATION REQUIREMENTS

When planning a grabwire installation, it is vital that the operators safety is always the primary objective. Plan the route of the 'Pull wire' carefully to ensure maximum accessibility by the possible users. Ensure that supports can be placed at a maximum of 2m spacing. The placement of the grabwire switches need to be in reachable positions for setting-up, monitoring and Resetting after an incident.

It is necessary to place the first eyebolt close to the switching body to ensure that if the wire is Pulled at a very oblique angle, then the Pull on the switch remains linear. Although corners/bends can be incorporated in the run, try to avoid too many. It may be necessary to install additional systems to ensure an effective installation. The ultimate objective must be to provide a free running 'Pull wire' with the minimum of resistance to movement.

Measure each run and select a Grabwire switch whose max. span (L) is greater than the measured distance. If the total length is over 100m, then multiple installations will be necessary. If the length is excessive, then consider using the 'LW' system. Choose the Stainless Steel grabwire switch option if the working environment will be continuously wet or subject to systematic cleansing routines.

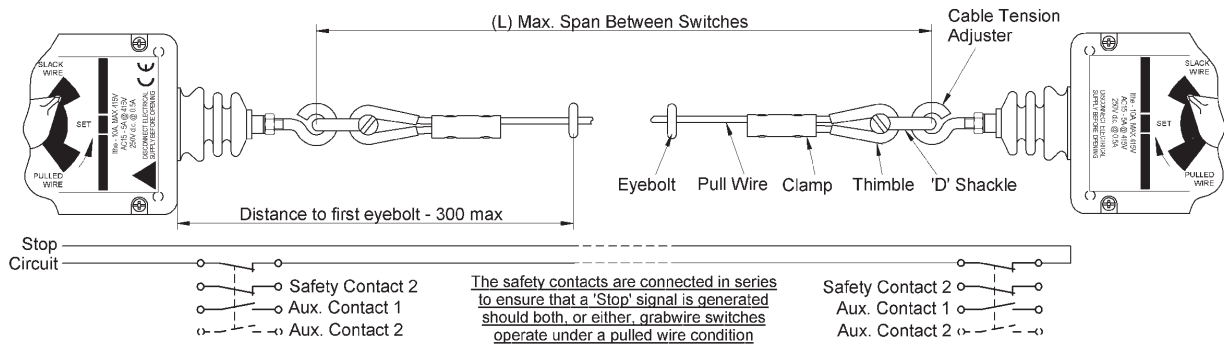

ACCESSORIES

To assist with the possible variations necessary when designing an installation, the following accessories are available.

Image	Cat. No.	Description
	GW/AB	Non Switching Anchor Box with manual Reset
	GW024A GW110A	Indicator lamp, which when powered through one of the spare N/O contacts, will indicate which grabwire switch has been actuated. (Indicates on 'Pulled' or 'Slack Wire' conditions) Supplied complete with bulb. Other colours and supply voltages available to order. 24V (Amber) Annunciator Lamp 110V (Amber) Annunciator Lamp
	MR 0221	Stranded steel 'Pull wire' with red PVC covering. (Ø5 approx O/D) Sold per Metre. Pull Wire (As supplied in the connecting kits)
	GWA 0070	Standard length 'eyebolt' for 'Pull wire' support. Supplied complete with 2 x locking nuts. Material - Stainless Steel, Size - M6, Overall length - 80, Thread length - 58 Standard M6 Eyebolt (As supplied in the connection kits)
	GWC 0270	Extended length 'eyebolt' for 'Pull wire' support. Supplied complete with 2 x locking nuts. Material - Stainless Steel, Size - M6, Overall length - 230, Thread length - 200 Extended M6 Eyebolt
	GWC 0163	Wrap around 'thimble' to terminate the 'Pull wire'. Material - Stainless Steel Termination 'thimble' (As supplied in the connection kits)
	GWC 0166	'D Shackle' to connect the 'Pull wire' to the grabwire switches. Material- Stainless Steel Connection 'D Shackle' (As supplied in the connection kits)
	GWC 0167	Cable clamp for securing the 'Pull wire' back upon itself once passed around the 'thimble'. Tightening via 2 x Allen screws. Material - Stainless Steel Cable clamp (As supplied in the connection kits)
	GWC 0189	Allen Key for tightening 'Cable Clamp' above. Size- 2.5 A/F Allen Key (As supplied in the connection kits)

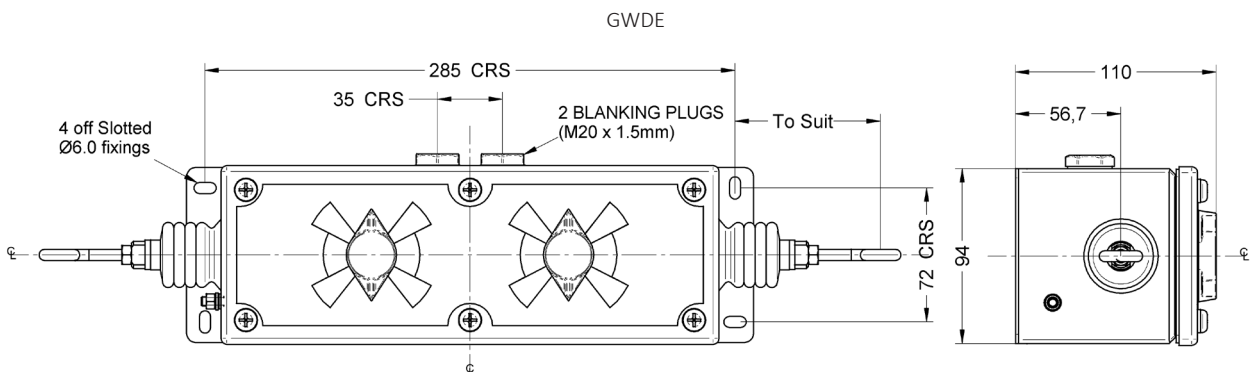
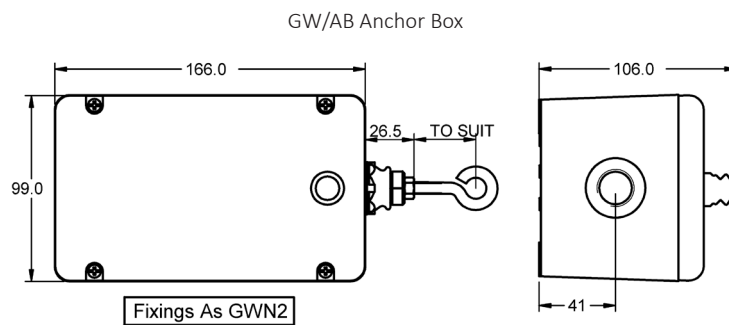
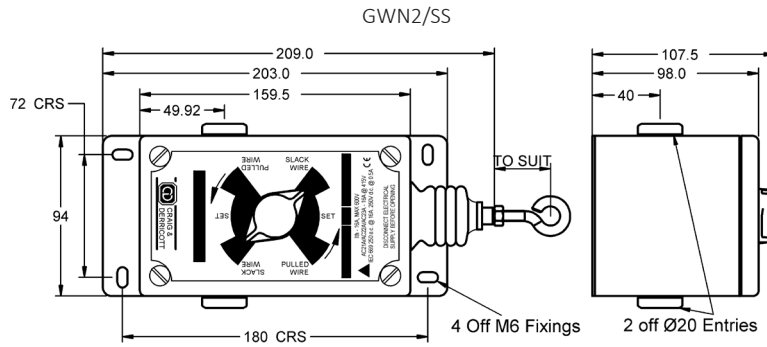
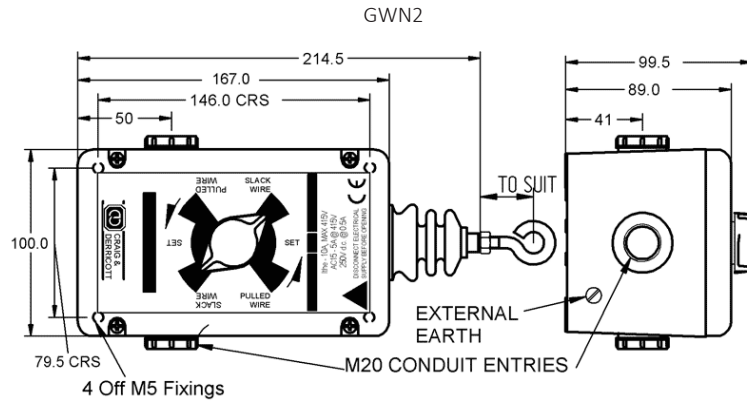
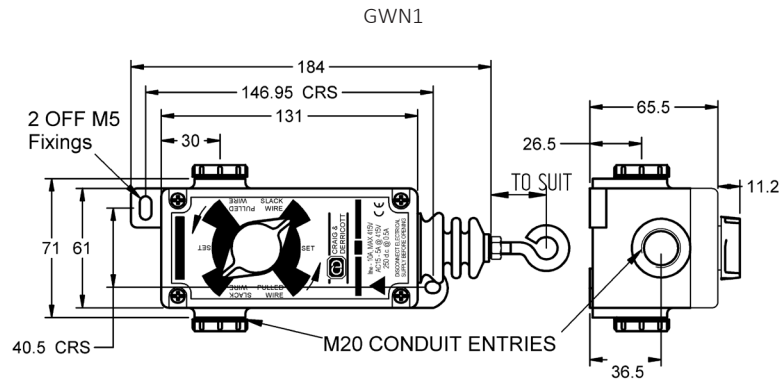

LW RANGE

Designed specifically for long distance protection, where a tensioned wire installation (GW series) becomes expensive or impractical. The 'LW' range system incorporates the following safety features:-

- The trip switch interior to each grabwire assembly contains positive push-off contacts.
- The system will trip in the event of-
 - a Grab-Line being Pulled in any direction.
 - a Grab-Line being broken or the Grab-Line circuit interrupted.
 - a short circuit condition occurring in the Grab-Line circuit.
 - a loss of power to the Control Station.
- Once tripped, the system requires manual Resetting.
- Only a safe low voltage is applied to the Grab-Line circuit and Grab-Line switch assemblies.

The system is ideal for heavy duty and exposed situations. The Control Station and Grab-Line switch assemblies are housed in substantial enclosures which are sealed to IP65. Stainless Steel components are used where necessary to ensure reliability is maintained.

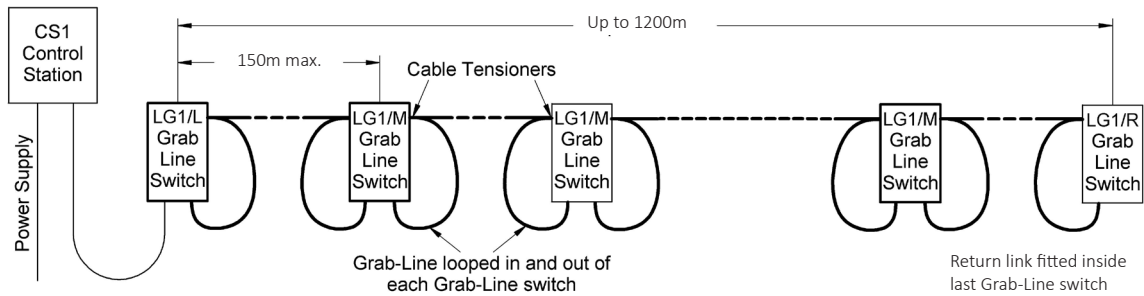
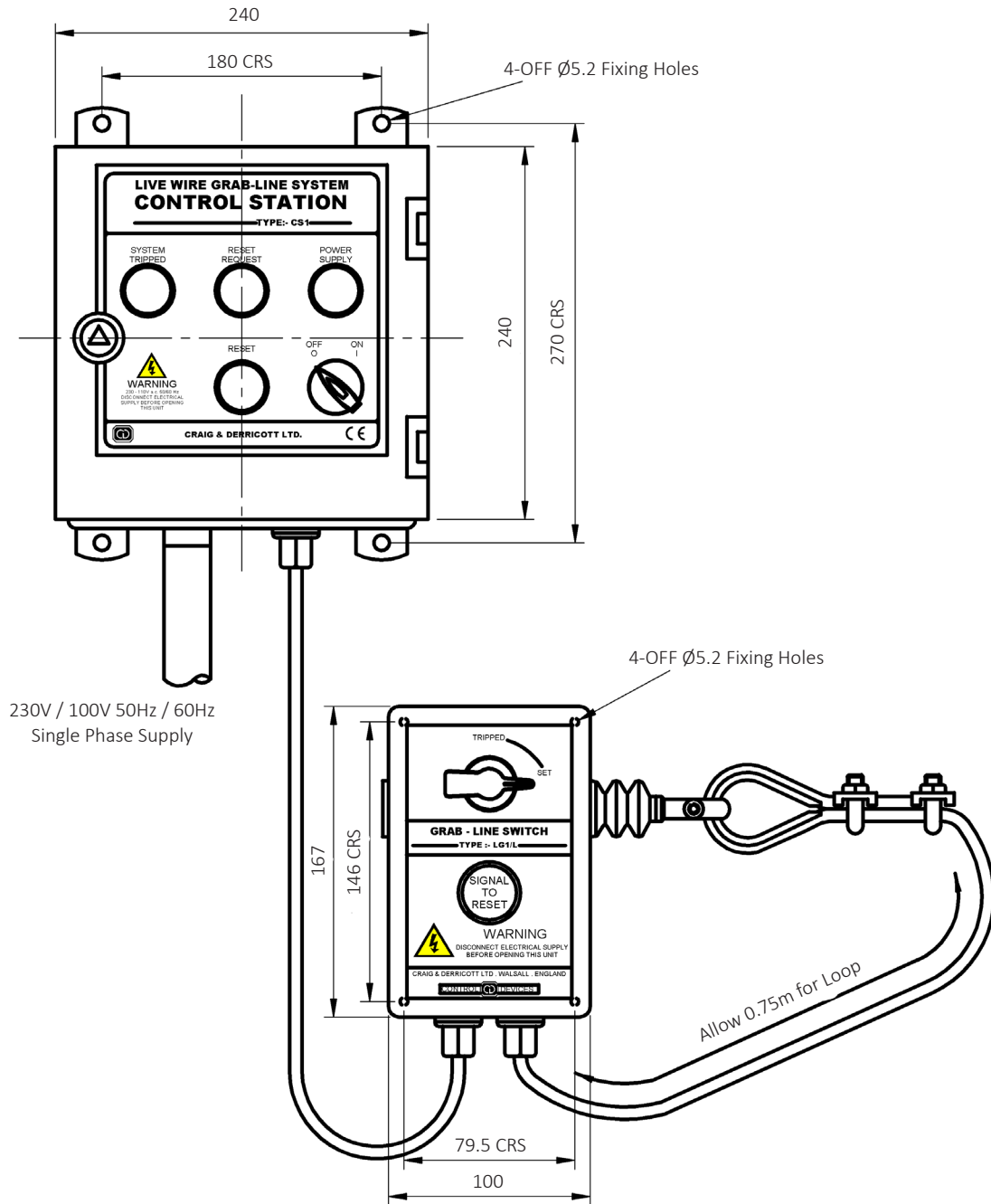

Image	Cat. No.	Description
	CS1	A control station assembly required for each installation. The Sheet Steel housed control station contains the following equipment: <ul style="list-style-type: none"> • On/Off switch • 'Supply On' Indicator Lamp (Blue) • 'Reset' Pushbutton • 'Reset System' Indicator Lamp (White) • 'System Tripped' indicator Lamp (Red)
	LG1/L	LH Grab-Line switch housed in heavy duty Die-Cast Aluminium enclosures. <ul style="list-style-type: none"> • Manual 'Reset/Condition Indicator' knob • 'Signal to Reset' pushbutton
	LG1/R	RH Grab-Line switch housed in heavy duty Die-Cast Aluminium enclosures. <ul style="list-style-type: none"> • Manual 'Reset/Condition Indicator' knob • 'Signal to Reset' pushbutton
	LG1/M	Mid Grab-Line switch housed in heavy duty Die-Cast Aluminium enclosures. <ul style="list-style-type: none"> • Manual 'Reset/Condition Indicator' knob • 'Signal to Reset' pushbutton
	GWC 0038A	Grab-Line cable (75m). Thick outer sheath of red PVC. Flexible steel wire armour
	GWC 0038B	Grab-Line cable (100m). Thick outer sheath of red PVC. Flexible steel wire armour
	GWC 0038C	Grab-Line cable (125m). Thick outer sheath of red PVC. Flexible steel wire armour
	GWC 0038D	Grab-Line cable (150m). Thick outer sheath of red PVC. Flexible steel wire armour
	GWA 0070	Stainless Steel Eyebolt with fixing nuts
	GWC 0031A	Grab-Line Thimble
	GWC 0032A	Grab-Line Clamp
	GWC 0033A	Grab-Line 'D' shackle
	GWC 0039	Cable gland

LW RANGE



Application		
Input Voltage		110V (15W max.), 240V (15W max)
System Voltage		24V a.c. - 1/2 wave rectified
Control Circuit Relay	Contact Operation	Positively operated
	Rated Load	3A at 240V a.c. 3A (Resistive) at 24V d.c.
	Max. Switching Current	6A
	Max. Switching Voltage	250V a.c. & 24V d.c
	Minimum Permissible Load	5V d.c.- 10mA
	Mechanical / Electrical Life	10 x 10 ⁶ /10 x 10 ³
	Contact Resistance	100 mΩ
Power Protection Fuse		2A
Safety Circuit Fuse		200mA
Max. Grab-Line Circuit Resistance		50 Ohms
Pull Force To Operate		Approx 5kg.

Full documentation and installation instructions are supplied with each control station

EV CHARGERS



A range of secure and reliable, 7.4kW domestic smart electric vehicle charging units.

Manufactured in the UK by Craig & Derricott, our Type 2 fast charging units are suitable for electric and plug-in hybrid vehicles.

Each smart charger has easy connectivity between the charger and our free smart IONcharge app. ION Charge also has the confidence of being independently tested and approved to all current UK regulations

Easy fit chargers | Value for money



SMART ION CHARGE RANGE

This range of 32A (7.4 kW) single phase Mode 3 smart EV chargers are an easy to fit solution for residential locations, complete with built in PEN fault, overload, ground fault, surge and 6mA DC leakage protection. Each smart charger comes with easy connectivity between the charger and the phone app and supplied with 2 RFID fobs, allowing quick charging authorisation when swiped against the unit.

- Manufactured in the UK with back-office support based in Europe as per GDPR regulations
- Plug & charge, integrated mobile app or RFID controlled charging
- Tamper proof charger, with push notifications to user app
- Dynamic load balancing (CT clamp & IONSens included)
- Power Management Group
- OCPP 1.6 compliant
- PME fault detection (no earth rod required)
- Over-the-air firmware / software updates
- Bluetooth / Wi-Fi / Ethernet connectivity
- Solar PV, battery storage or wind turbine integration
- Built-in over current & 6mA DC leakage protection
- A type A RCD/RCBO must be fitted and placed upstream of the EV charger
- Integrated Smart App on Android and iOS
- Integrated RFID reader
- IK10 impact resistant design
- Type 2 socket or 5m Type 2 tethered lead
- LED Status Indication
- 7.4kW charging output
- Independent back plate for easy wall or post mounting
- Additional front covers in various colours are available

SOCKETED SMART EV CHARGER EVO3221000



- Type 2 socket connection
- Plug & charge, integrated mobile app or RFID controlled charging
- 3 year warranty from proof of purchase
- EV Charger is supplied standard with a black cover. Additional colours are available on request: White, Green, Red and Brown

TETHERED SMART EV CHARGER EVO3221010



- Type 2 holster, car plug and 5 metre cable
- Plug & charge, integrated mobile app or RFID controlled charging
- 3 year warranty from proof of purchase
- EV Charger is supplied standard with a black cover. Additional colours are available on request: White, Green, Red and Brown

COMPLIANT TO:

- EV Charging Compliance – EN 61851-1:2019 | EN 61851-22:2002
 - Wiring Regulations – BS 7671:2018 + A2:2022
 - EMC Compliance – ETSI EN 301489-1 V2.2.3 | ETSI EN 301489-3 V2.1.1 | ETSI EN 301489-17 V3.2.4 | SI 2016/1091
 - Safety Compliance (LVD) – EN 62368-1:2020 + All 2020/ EU | SI 2016/1101
 - Smart Charge Points – (SI 2021/1467)
 - Environmental Protection – BS EN 60529:1992 + A2:2013
 - Impact Rating – BS EN 62262:2002 + A1:2021
 - RoHS – 2011/65/EU | SI 2012/3032
 - REACH – 1907/2006, REACH etc. (Amendment) Regulations 2021
 - Certification Markings – CE & UKCA
- Statement correct at time of print.

STAY SMART WITH C&D



Available on Android and iOS

THE SMART APP

- Live and historic charging data can be accessed easily from the clear user dashboard in the app.
- Insights include power consumption, session durations, costs and CO2 savings. Users can input their tariff kWh prices to get accurate energy costs.
- Default charging sessions are pre-set to avoid peak electricity demand. Drivers can override these default schedules.
- Access controls ensure no unauthorised vehicles will be able to begin a charging session. Charging sessions must be started through the RFID card or the app.

DIMENSIONS

SOCKETED (UNTETHERED)

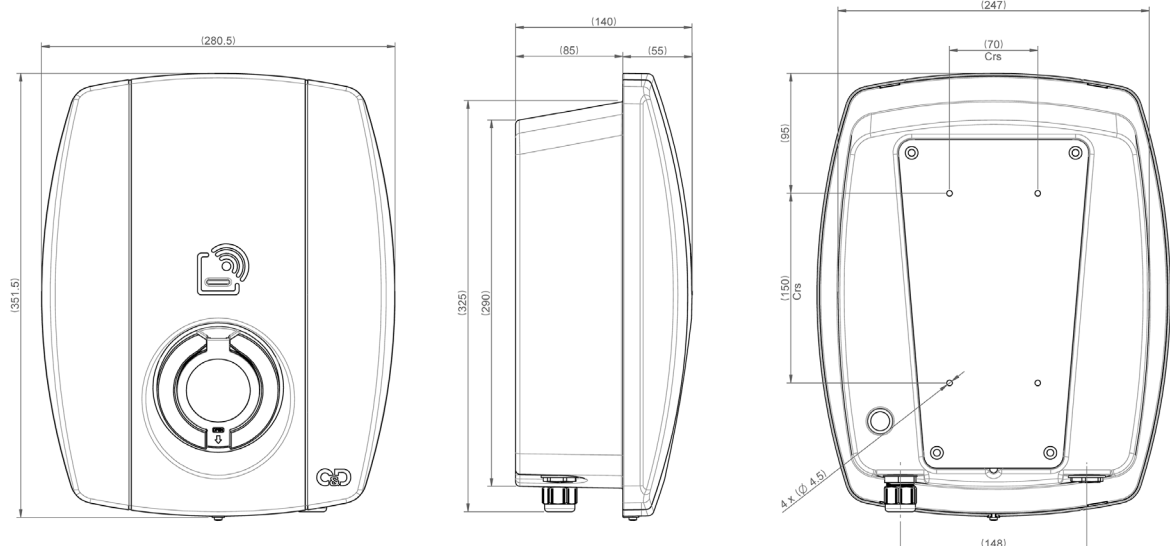

TETHERED

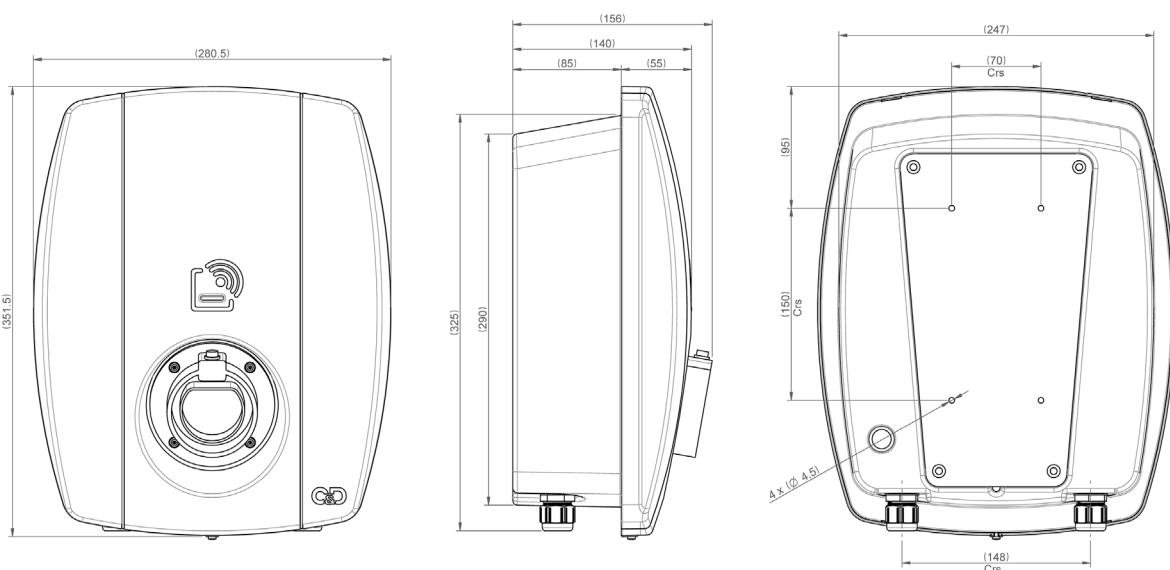

STANDARD ROTARY SWITCHES

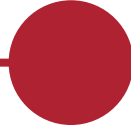

Our hand operated rotary switches offer a cost effective way of performing complex switching functions.

- They don't require any form of separate expensive power supply.
- Total freedom in the way contacts are made to open and close.
- The indexing positions can vary between 2 and 12.
- Contacts can be provided capable of switching low energy or high power; from a few milliamps up to 125A.
- A vast array of alternative operating handles can provide interlocking and other safety features.
- Early break, late break, make-before-break and fleeting contact conditions are available for use.

Visit our website www.craigandderricott.com to download a copy of our i-select range PDF.

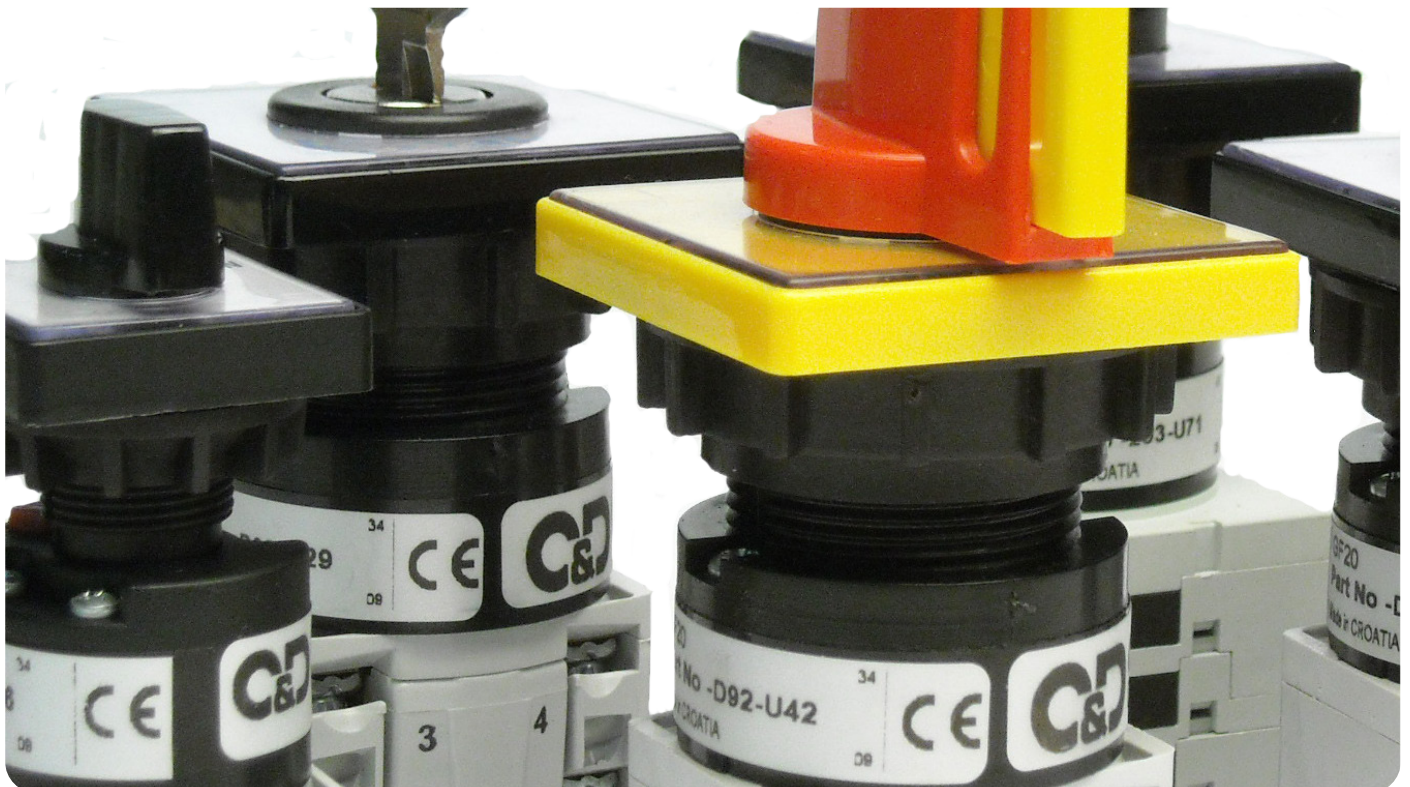

CLASSIC ROTARY SWITCHES

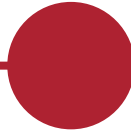

Our hand operated rotary switches provide a cost-effective method of providing complex contact switching functions. Every item of electrical equipment needs a method of disconnecting it safely from the supply, and our classic rotary switch range performs that function effectively.

We offer four types of rotary switches: R6, R16, Mini-Rotary & R40, which are available in the following formats:

- Changeover
- Cumulative
- Heaters
- Metering
- Motor Control
- Multi-Position
- Off / On



FLAGGED ISOLATORS



Craig & Derricott offer a range of hinged door enclosed isolators and switch fuses, available in ratings 32A to 400A (as standard), where each unit is supplied with a flag indicator. The indicator is viewed through a 8mm thick polycarbonate window in the enclosure door providing the user with confirmation of the switch contact state. All assemblies are sealed to IP65 and are supplied with 2 C/O auxiliary blocks wired down to terminals.

Standard Flag isolators are supplied with silver plated conductors but if the product is to be installed in an environment where there is a high amount of Hydrogen Sulphide and Sulphur dioxide, we offer the option of Tin plated conductors in order to prevent the growth of silver whiskers. Stainless Steel Grade 304 enclosures, Castell Lock options and EX Zone 22 versions are available on request.



BESPOKE DESIGN

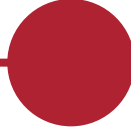

Craig & Derricott has been manufacturer for 100 years and in that time has earned a reputation for well engineered products with the ultimate in reliability. Alongside our standard catalogue products, we offer a bespoke and special product service known as mi-switch, enabling customers to specify exact requirements which can be made to order.

We have a dedicated team of specialist engineers who can draw upon their vast experience to provide you with a unique design solution to meet your specific requirements. For too long customers, installers and specifiers have tried to mix and match component parts to meet their needs, but now you can simply hand over your project to us and we will create the ideal and most cost effective solution to your requirements.

Just contact us on +44 (0)1543 375 541 to discuss your requirements and we'll be happy to provide some options as to how this can be achieved.



AREA SALES MANAGERS

Cannot find what your looking for in this brochure? Contact our sales team to discuss your requirements with us today.

+44 (0)1543 375 541 | sales@craigandderricott.com | www.craigandderricott.com



RAJ LAGAH

Area 2 & 4

07525 129 798

rlagah@craigandderricott.com



DAVE HOLLAND

Area 3

07525 129 797

dholland@craigandderricott.com



JON BROCK

Area 5

07719 068 346

jbrock@craigandderricott.com



LYNDSEY PRYCE

Area 6

07973 971 923

lpryce@craigandderricott.com



JEN BRATT

Area 7

07701 305 147

jbratt@craigandderricott.com



ADRIAN MARTIN

Area 8

07944 109 509

amartin@craigandderricott.com

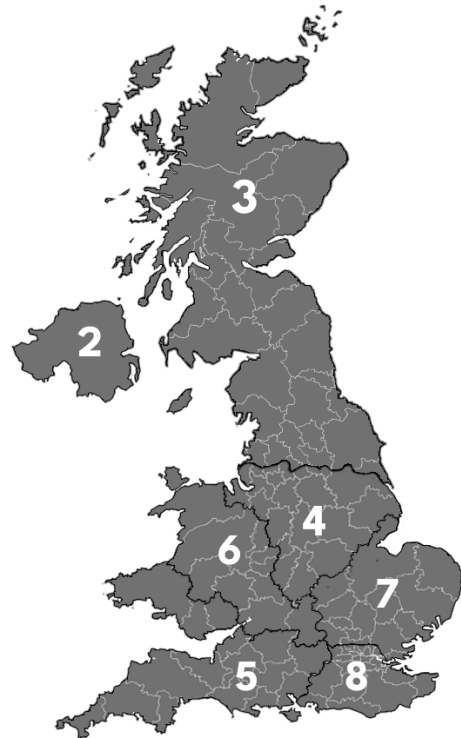

VISIT OUR WEBSITE

WWW.CRAIGANDDERRICOTT.COM



MAKE A NOTE

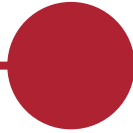

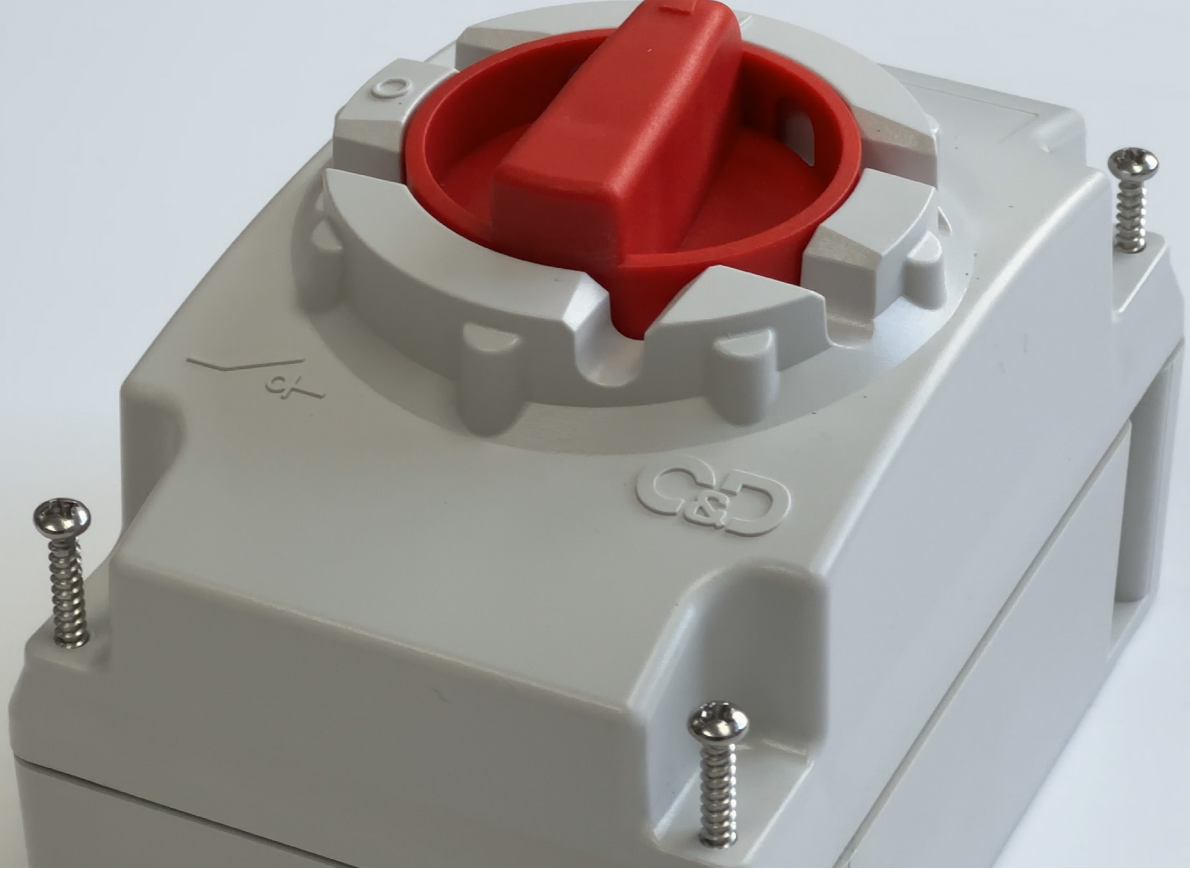

INDUSTRIAL CATALOGUE



46 HALL LANE
WALSALL WOOD
WALSALL
WEST MIDLANDS
WS9 9DP

+44(0)1543 375541
SALES@CRAIGANDDERRICOTT.COM

WWW.CRAIGANDDERRICOTT.COM